



Warning



- Ask a qualified installer or contractor to install this product. Do not try to install the product by yourself. Improper installation can result in water or refrigerant leakage, electrical shock, fire or explosion.
- Use only those parts and accessories supplied or specified by Daikin. Ask a qualified installer or contractor to install those parts and accessories. Use of unauthorised parts and accessories or improper installation of parts and accessories can result in water or refrigerant leakage, electrical shock, fire or explosion.
- Read the user's manual carefully before using this product. The user's manual provides important safety instructions and warnings. Be sure to follow these instructions and warnings.

If you have any enquiries, please contact your local importer, distributor and/or retailer.

#### Cautions on product corrosion

1. Air conditioners should not be installed in areas where corrosive gases, such as acid gas or alkaline gas, are produced.
2. If the outdoor unit is to be installed close to the sea shore, direct exposure to the sea breeze should be avoided. If you need to install the outdoor unit close to the sea shore, contact your local distributor.



PCSHK1549-1

# Super Inverter

## Energy saving and Compact

# SkyAir

Cooling only -50Hz-  
Heat pump -50Hz-



INVERTER R-410A



**Achieves both compact design and excellent overall energy saving.**  
**More benefits with ultimate air conditioning comfort.**

# New Inverters launched!

# SkyAir

**Super Inverter**

**Cooling only**



5.0-7.1 kW class



10.0-14.0 kW class



## Energy saving

P.3

This new series has been designed to meet ISO criteria for CSPF\*. Compared with non-inverter models, annual power consumption is about 50% less. Not only is power consumption reduced during low-load periods, but cooling capacity is better during peak load periods.

\*CSPF, cooling seasonal performance factor

## Compact

P.4

Comes with highly efficient heat exchanger and, through optimized design of the system circuit, the outdoor unit is even more compact!

## Comfort

P.5

As well as the comfort provided by inverter control, the 'Quick cooling start' function more quickly lowers room temperature and dehumidifies the air.

## Convenient functions

P.8

Advanced Daikin inverter technology brings various benefits to owners.

## Design flexibility

P.10

- Possible to force On-Off using external command.
- Ability to connect to high level control system without optional adaptor.

## Durability

P.7

With automatic safeguards to protect against low voltage, the system is tough enough to withstand supply voltage fluctuations.

## Reuse of existing piping

P.9

Reuse of existing piping makes it easy to upgrade indoor and outdoor units.

## Smart airflow control

P.11

Smart airflow enables flexible installation to room conditions without affecting comfort.

# Energy saving



Throughout the cooling season, Daikin's new inverter models reduce energy consumption **NEW**

Compared with previous non-inverter series, the new RZR-M series uses about 50% less power consumption. Get quick and effective cooling, and cut electricity bills.

Comparison of cooling seasonal power consumption based on average CSPF values

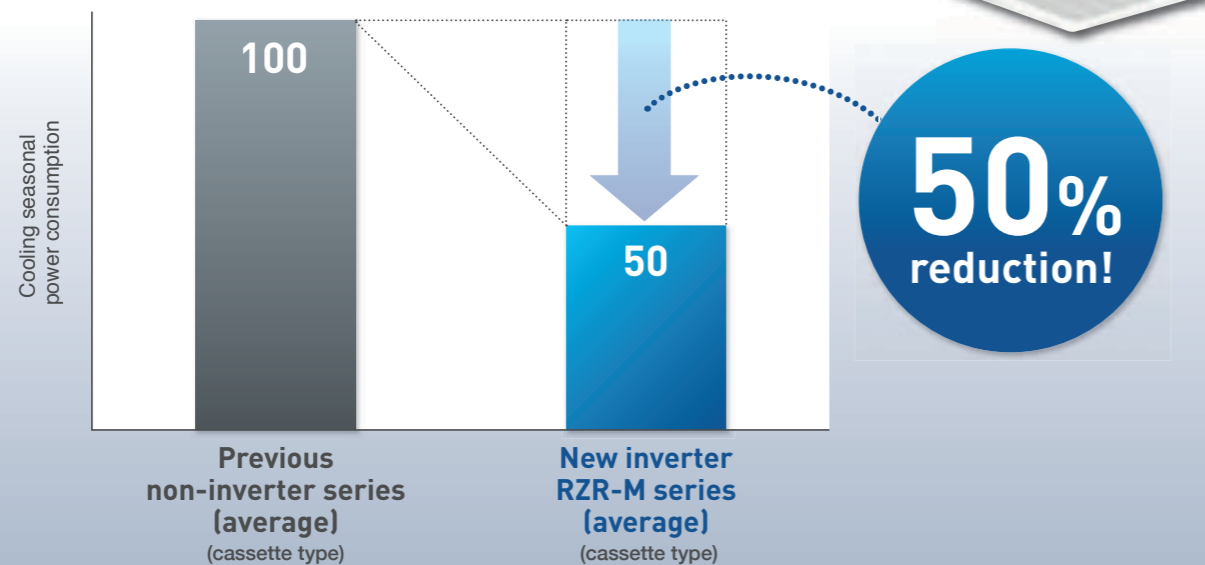

Note: Value 100 represents the amount of electricity used by a non-inverter model during a similar annual cooling period.

CSPF values by capacity for cassette models

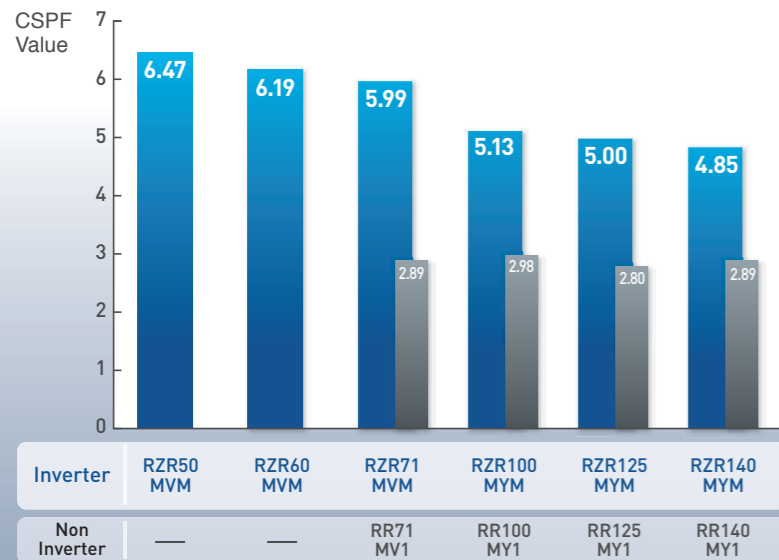

■ New inverter RZR-M series R410A (cassette type)  
 ■ Previous non-inverter series R410A (cassette type)

\* CSPF (cooling seasonal performance factor) is a new international energy-efficiency criterion calculated by methods stipulated in ISO 16358-1.

### What is CSPF?

CSPF is the value for the annual total cooling load divided by the annual total power consumption at outdoor air condition specified by ISO standard.

Super Inverter

# Compact

New outdoor units save even more space **NEW**

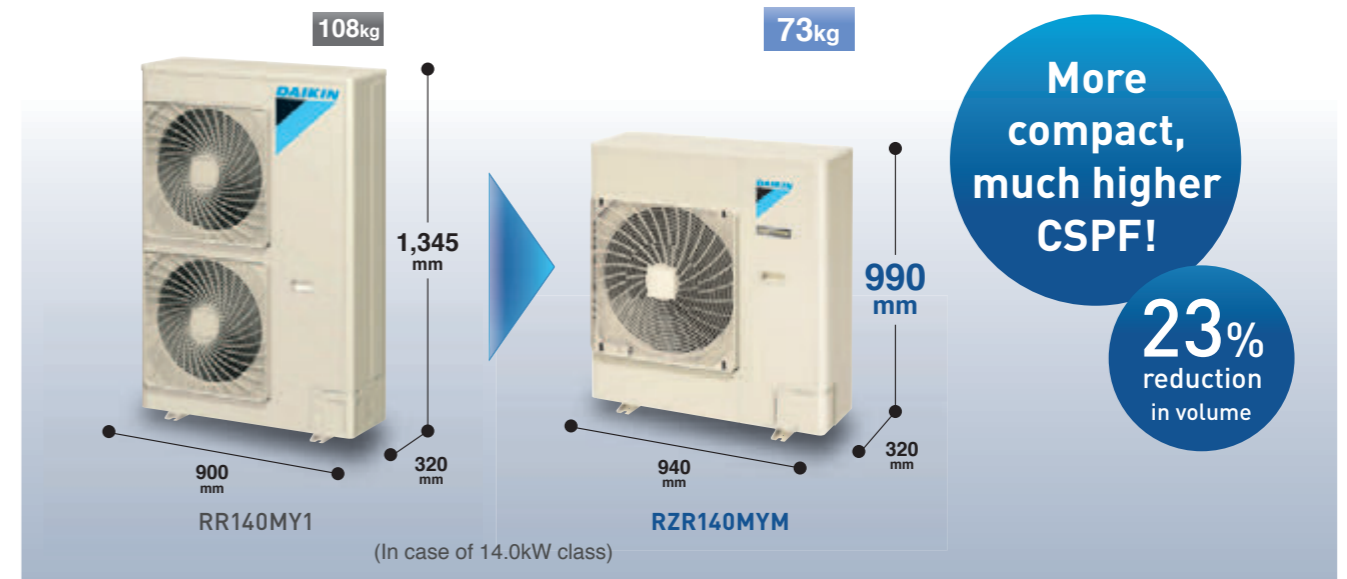

Compared to the previous mainstream non-inverter series, outdoor units are much more compact. Easy installation in places with limited space.

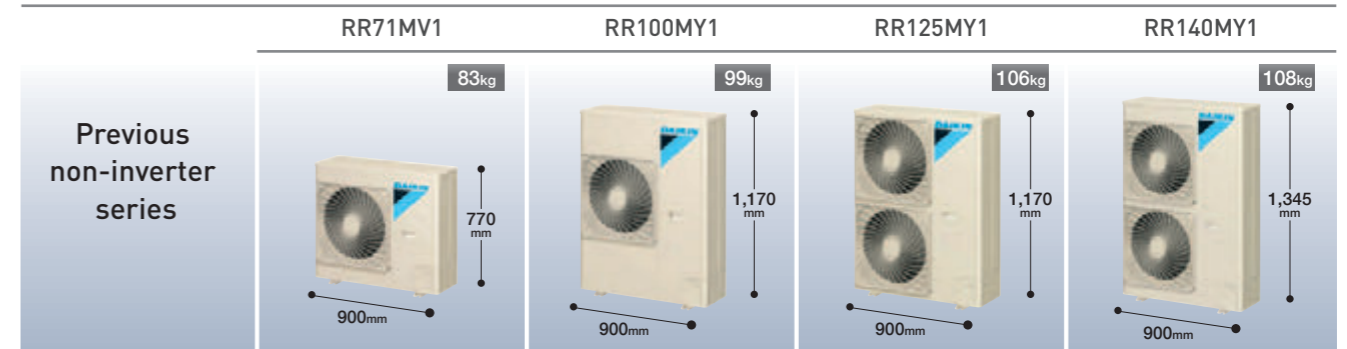

# Comfort



## Faster cooling and dehumidification: New inverter control technology brings quick comfort (RZR-M series)

**NEW**

### Quick cooling start function

Quickly and easily make space comfortable before the arrival of office workers or shop customers. As well as quick cooling at max. capacity, new inverter control rapidly removes indoor humidity. More than simple temperature reduction, this twin reduction provides greater comfort (within 30 minutes max.).



- ➔ New Inverter (RZR-M series)
- ➔ Usual Inverter (RZR-L series)
- ➔ Non inverter

● BRC1E63 wired remote controller is used for 'Quick cooling start'.

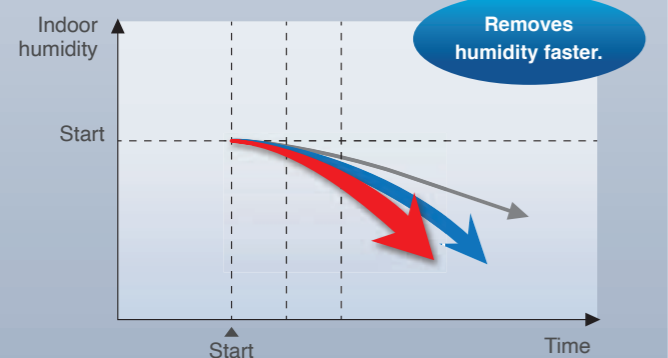
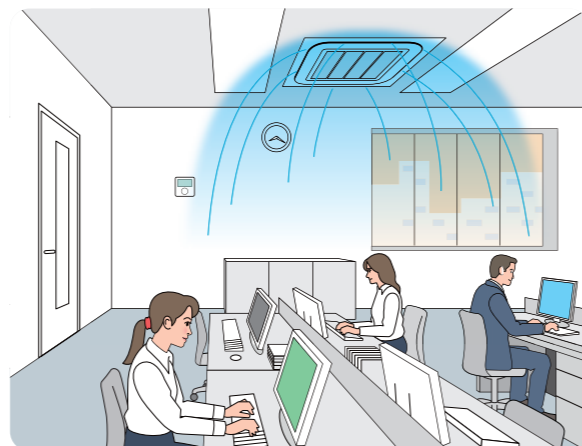
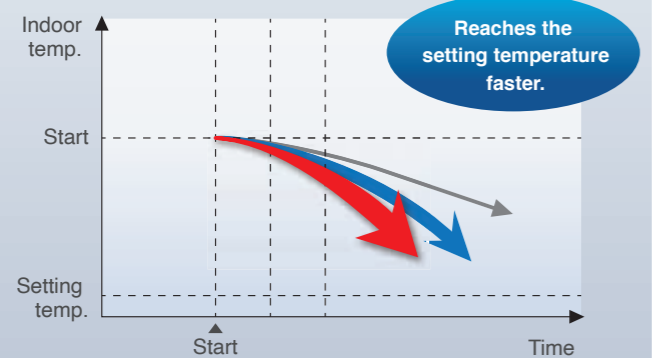
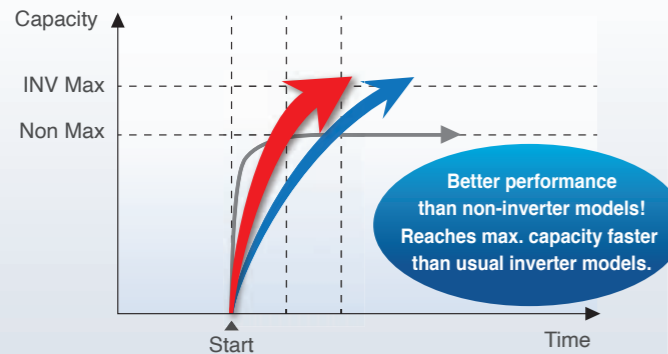

# Benefits of Inverter

**Super Inverter**

## Why is inverter technology economical?

Inverter system consumes less electricity, and soon recovers the difference in initial cost. This results in lower total cost.

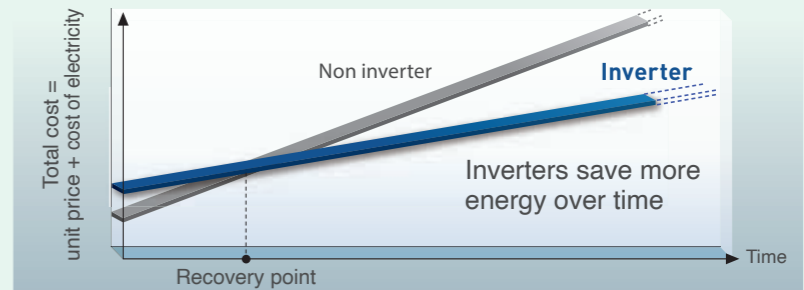

Inverter air conditioner can adjust its cooling capacity according to the cooling load. This results in less power consumption.

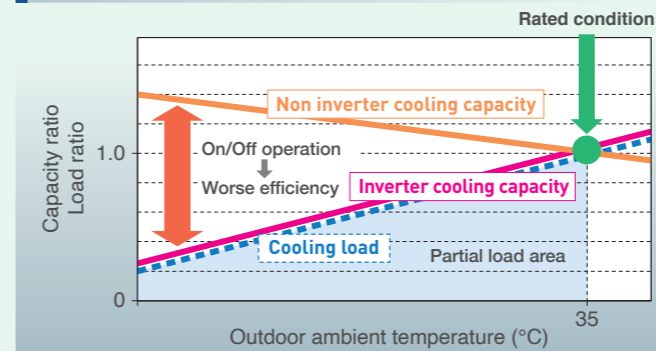

In response to fluctuating cooling load, non-inverter air conditioners repeatedly perform On (full-power)/Off (zero-power) operation. Inverter air conditioners, however, operate at optimal cooling capacity according to the cooling load. Since inverter air conditioners provide required minimum cooling capacity with minimum electrical power, total power consumption can be reduced during cooling period.

Inverters operate without repeated On/Off operation.

### Inverter Highway driving

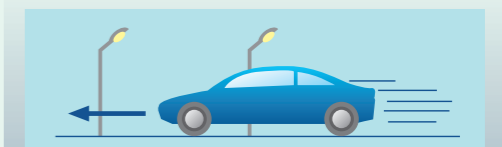

Continuous driving without stopping and starting is more fuel efficient.

### Non inverter City driving

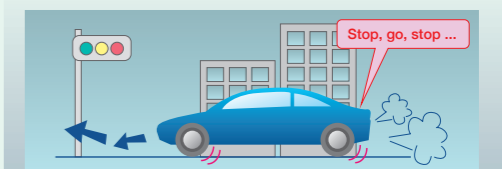

Constantly stopping and starting consumes energy and is less fuel efficient.

## Why is inverter technology more comfortable?

When temperature does not fluctuate much, the set temperature is maintained.

Inverter control responds to load changes and causes minor temperature adjustments. Non-inverter control frequently turns ON and OFF in response to load fluctuations or load mismatch and causes large temperature swings.

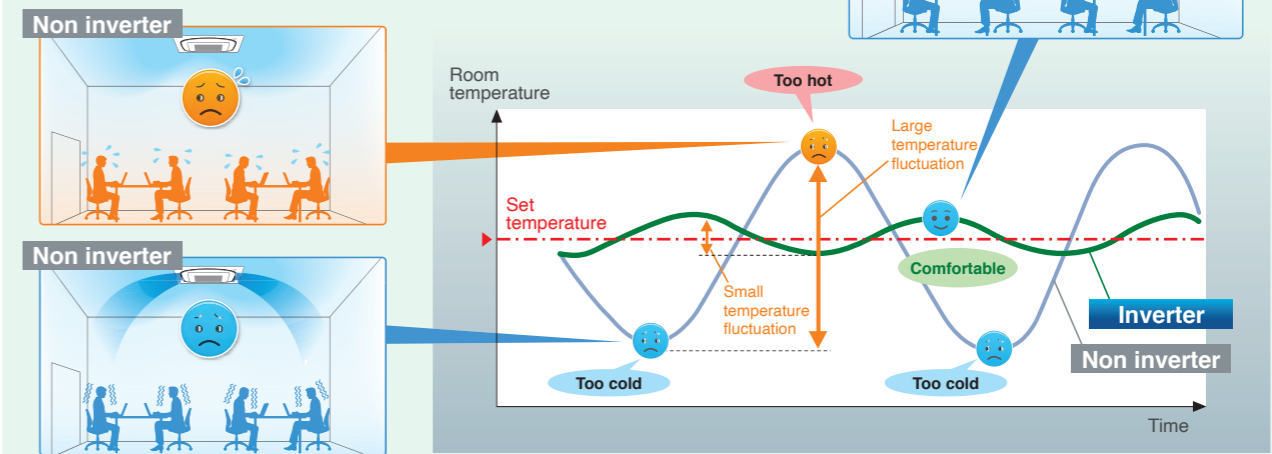

# Durability

## Automatic protection against low voltage

In AM and PM peak electricity consumption periods, supply may fluctuate. Built-in low-voltage protection will automatically cut operations. When normal voltage is restored, operation will resume as before.

## Outdoor unit installation is possible even with limited space

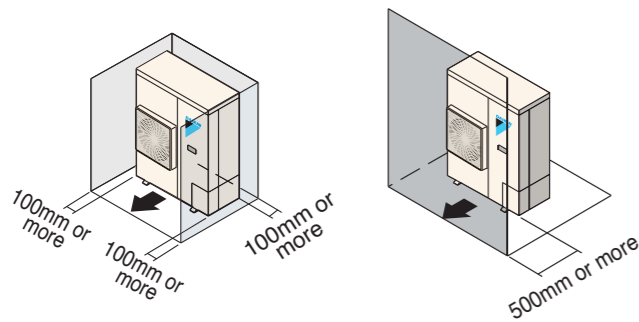

## Coated printed circuit boards

Coated circuit boards prevent problems caused by humidity and airborne dust.



## Self-diagnosis functions enable prompt maintenance response

An error message appears on the LCD of the remote controller and an LED lights up on the unit. When the BRC1E63 is installed, the error code appears showing contact information and model name. Contact your Daikin dealer and provide the error code and model name.



# Convenient functions

Super Inverter

And more... Advanced Daikin inverter technology brings various benefits to owners and installers.

## Navigation remote controller BRC1E63 includes various convenient functions

### Automatic return to temperature preset by owner.

#### Setpoint auto reset

- Even if the set temperature is changed, after a preset period new set temperature returns to preset value.
- Period selectable from 30, 60, 90, or 120 minutes.

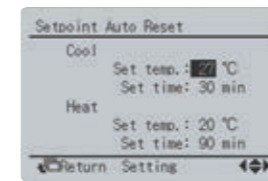

### Owner can preset upper and lower temperatures.

#### Setpoint range set

- Saves energy by limiting the min. and max. set temperature.
- Avoids excessive heating or cooling.
- This function is convenient if the remote controller is installed where anyone can change the settings.

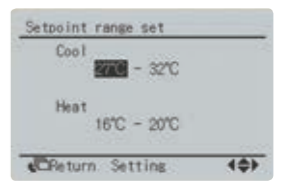

**Restaurant example**

Temperature is set to 27°C

Then is lowered to 24°C for crowded room

Automatically returns to preset temperature (27°C)

\*Preset-return time can be set at 30, 60, 90, or 120 min

## Demand Control Function

By setting limits that restrict power consumption, you can cut electricity bills.

Power consumption is given first priority, and limits maximum power consumption of unit. Maximum power consumption can be set at 40, 60, 70, 80, or 100%.

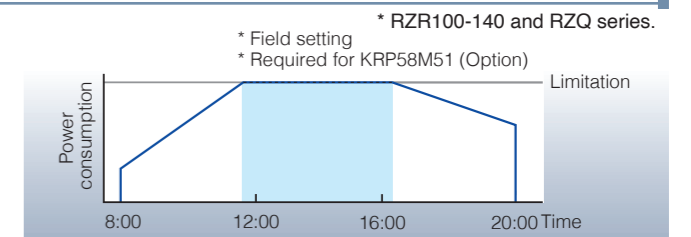

## More economy or comfort in special situations (Cooling only)

\*Please refer to Service Manual.

## High sensible cooling enables even greater power savings



In locations such as simple server rooms, dehumidification is not required and greater power savings are possible with 'High sensible cooling' mode.

\*Available with RZR-M series. Field setting with remote controller.

## High dehumidification cooling provides even greater comfort



In restaurants and other spaces where many people gather, 'High dehumidification cooling' mode reduces humidity and creates greater comfort.

\*Available with RZR100-140M models. Field setting on outdoor unit.

## Night quiet operation mode

### Consideration for people living nearby

Outdoor unit operating sound can be reduced.

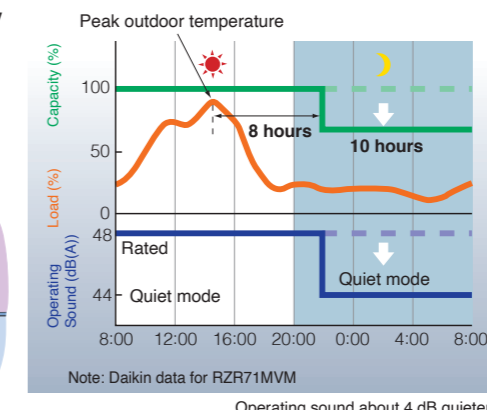
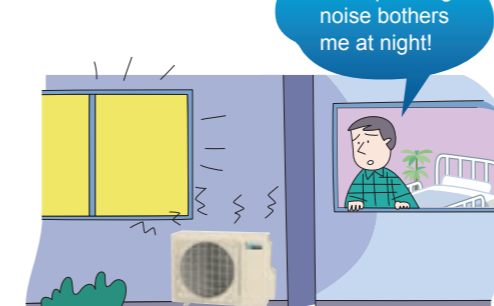

\*Field setting with remote controller



# Reuse of existing piping

(RZR-M series only.)

## Benefit 1 Simplified installation reduces replacement time and cost

When considering air conditioner replacement, do the following things concern you?

- For how long will the business have to close down? While replacement work is going on, how will sales be affected?
- Won't the costs be high and work period longer because scaffolding is necessary for pipe replacement?

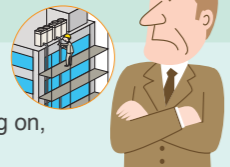

These problems are solved by Daikin!

Where feasible, by reusing existing pipes\*, we cut your work cost and reduce work time.



\*Strict conditions apply, please check the table on page 43 for acceptable pipe sizing (if pipes are to be reused).

## Benefit 2 You can increase cooling capacity and achieve higher energy efficiency

Upgrade to an air conditioner with the latest technology for greater comfort and energy efficiency.

R410A Non inverter 7.7 kW class

R410A inverter 14.0 kW class

Pipes used as they are!

As a result, the greater capacity units ensure better performance to cope with the increasing amount of heat generated by office equipment and occupants.

## Technology

Advanced technology including the use of corrosion resistant electronic expansion valves, acid neutralisers and improved compressor reliability enables the re-use of existing piping\* without the need of pipe flushing for a simplified replacement process.

<p><b>Stronger refrigerating machine oil</b></p> <p>An acid neutraliser agent is added to disable acids (chlorine ions), which cause corrosion.</p> <p>Acid neutraliser</p> <p>Acid (chlorine ion)</p> <p>Refrigerant pipe</p>	<p><b>Highly corrosion resistant electronic expansion valve</b></p>	<p><b>Highly reliable compressor</b></p> <p>Compressor durability is improved by installing a filter or accumulator to collect solid foreign substances.</p> <p>Filter or accumulator</p> <p>Compressor</p>
--	---	---

\*Strict conditions apply, please check the table on page 43 for acceptable pipe sizing (if pipes are to be reused).

# Design flexibility

Super Inverter

## Possible to force On-Off operation using external command

(Available in duct connection middle static pressure type and wall mounted type)

\*Field setting with remote controller

Off-operation never overlooked if linked to use of hotel keycard: enables overall power savings.

Duct connection middle static pressure type : FBQ-E series

Wall mounted type : FAQ-C series

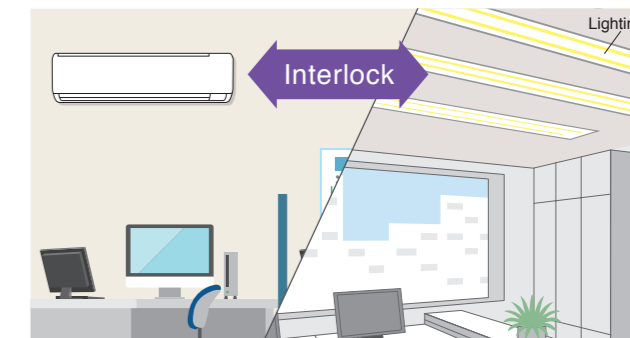
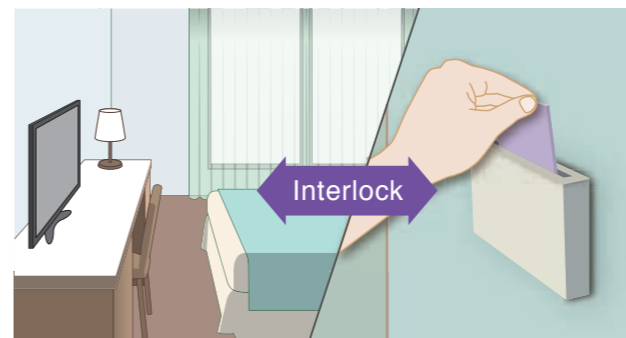

\*Other type of indoor unit is available by using optional adapter.

## All indoor units comply with DIII-Net standards (Connected to RZR and RZQ series units)

**Previous indoor unit**

Optional interface adaptor is required

**New indoor unit**

Adaptor not required

Thanks to easy connection to DIII-NET and long piping length, suitable for projects that include VRV and SkyAir.

# Smart airflow control

**All indoor units can provide 3-step fine control of air volume**  
(Connected to RZR and RZQ series units)

**Comfort ensured by 'Auto' airflow rate that matches load level**  
(Available in wall mounted type and duct connection middle static pressure type)

Convenient energy-efficiency for stores with peak and quiet periods.

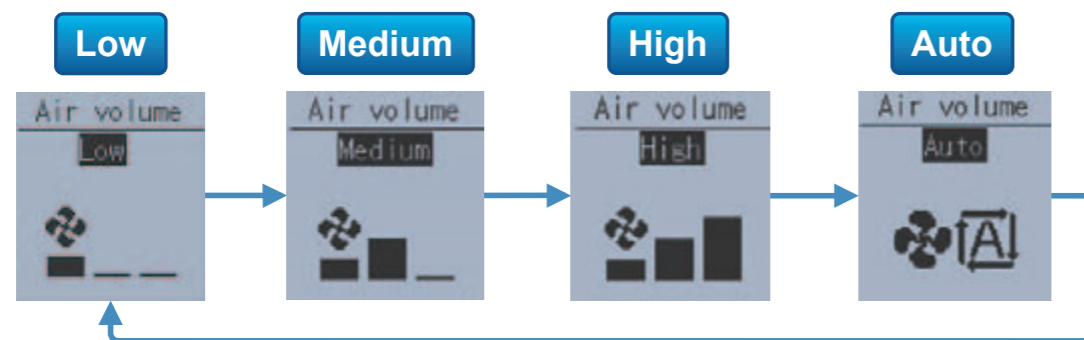
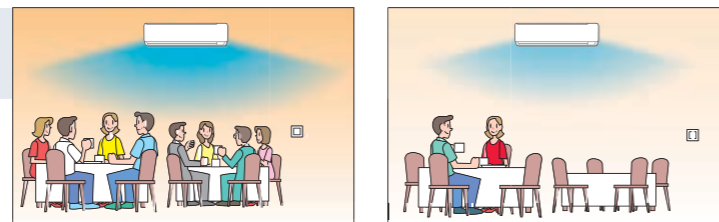

**Also convenient for high ceilings and spaces with long blow distances**

Cassette type <Round Flow>:  
max. 4.2 m

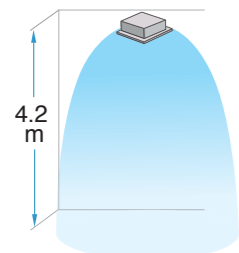

See page 21

Ceiling suspended type:  
max. 4.3 m

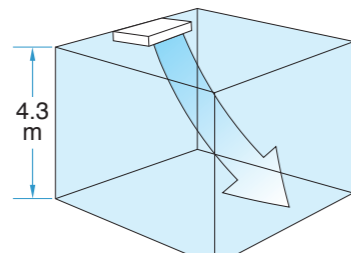

See page 26

\*Field setting with remote controller



**Airflow pattern is selectable to match room shape and installation location**

**Cassette type <Round Flow>**

**Typical flow patterns** There are a total of 23 flow patterns. See page 20-21

You can freely set air discharge setting by remote controller.

<b>L-shaped 2-way flow</b> (E.g., installed in a corner)	<b>Opposite 2-way flow</b> (E.g., installed in a long room)
<b>All-round flow</b> (E.g., installed in middle of ceiling) 4-way flow also possible.	<b>3-way flow</b> (E.g., installed near a wall)

(1) Standard setting

(2) Ceiling soiling prevention setting

**Compact multi flow cassette type**

**Multi-Flow System** See page 24

<b>4-way flow</b> 1 pattern		(1) Standard setting	
<b>3-way flow</b> 4 pattern		(2) Draft prevention setting (Set on site)	
<b>2-way flow</b> 1 pattern		(3) Setting to prevent soiling of ceiling (Set on site)	

**Ceiling suspended type**

**Long or wide airflow** See page 26

# Product Lineup

Cooling only



Series	25	35	50	60	71	100	125	140	
<b>CEILING MOUNTED CASSETTE TYPE</b> <Round Flow> 			<b>NEW</b> 	<b>NEW</b> 		<b>NEW</b> 	<b>NEW</b> 	<b>NEW</b> 	<b>NEW</b> 
			FCQ50KAVEA RZR50MVM	FCQ60KAVEA RZR60MVM		FCQ71KAVEA RZR71MVM	FCQ100KAVEA RZR100MYM	FCQ125KAVEA RZR125MYM	FCQ140KAVEA RZR140MYM
<b>COMPACT MULTI FLOW CEILING MOUNTED CASSETTE TYPE</b>									
	Indoor unit FFQ25BV1B Outdoor unit RKS25EBVMA	Indoor unit FFQ35BV1B Outdoor unit RKS35EBVMA	Indoor unit FFQ50BV1B Outdoor unit RKS50FVMA	Indoor unit FFQ60BV1B Outdoor unit RKS60FVMA					
<b>CEILING SUSPENDED TYPE</b>			<b>NEW</b> 	<b>NEW</b> 		<b>NEW</b> 	<b>NEW</b> 	<b>NEW</b> 	<b>NEW</b> 
	Indoor unit FHQ35BVV1B Outdoor unit RKS35EBVMA	Indoor unit FHQ50DAVMA Outdoor unit RZR50MVM	Indoor unit FHQ60DAVMA Outdoor unit RZR60MVM		Indoor unit FHQ71DAVMA Outdoor unit RZR71MVM	Indoor unit FHQ100DAVMA Outdoor unit RZR100MYM	Indoor unit FHQ125DAVMA Outdoor unit RZR125MYM	Indoor unit FHQ140DAVMA Outdoor unit RZR140MYM	
<b>WALL MOUNTED TYPE</b>						<b>NEW</b> 			
	Indoor unit FAQ100CVEA Outdoor unit RZR100MYM								
<b>DUCT CONNECTION MIDDLE STATIC PRESSURE TYPE</b>			<b>NEW</b> 	<b>NEW</b> 		<b>NEW</b> 	<b>NEW</b> 	<b>NEW</b> 	<b>NEW</b> 
	Indoor unit FBQ50EVE Outdoor unit RZR50MVM	Indoor unit FBQ60EVE Outdoor unit RZR60MVM		Indoor unit FBQ71EVE Outdoor unit RZR71MVM	Indoor unit FBQ100EVE Outdoor unit RZR100MYM	Indoor unit FBQ125EVE Outdoor unit RZR125MYM	Indoor unit FBQ140EVE Outdoor unit RZR140MYM		
<b>OUTDOOR UNIT</b> 			<b>NEW</b> 	<b>NEW</b> 		<b>NEW</b> 	<b>NEW</b> 	<b>NEW</b> 	<b>NEW</b> 
	Outdoor unit RZR50MVM	Outdoor unit RZR60MVM		Outdoor unit RZR71MVM	Outdoor unit RZR100MYM	Outdoor unit RZR125MYM	Outdoor unit RZR140MYM		
<b>OUTDOOR UNIT</b> 									
	Outdoor unit RKS25EBVMA	Outdoor unit RKS35EBVMA	Outdoor unit RKS50FVMA	Outdoor unit RKS60FVMA					

Page 19

Page 23

Page 25

Page 27

Page 31

























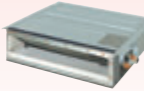
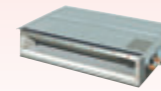
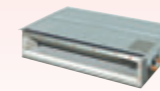
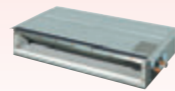
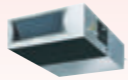
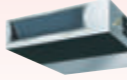



Page 33



# Product Lineup

Heat pump



Series	25	35	50	60	71	100	125	140		
<b>CEILING MOUNTED CASSETTE TYPE</b> <Round Flow>  Indoor unit Outdoor unit					NEW  FCQ71KAVEA RZQ71LV1	NEW  FCQ100KAVEA RZQ100HAY4A	NEW  FCQ125KAVEA RZQ125HAY4A	NEW  FCQ140KAVEA RZQ140HAY4A	Page 19	
<b>COMPACT MULTI FLOW CEILING MOUNTED CASSETTE TYPE</b> Indoor unit Outdoor unit	 FFQ25BV1B RXS25EBVMA	 FFQ35BV1B RXS35EBVMA	 FFQ50BV1B RXS50FVMA	 FFQ60BV1B RXS60FVMA					Page 23	
<b>CEILING SUSPENDED TYPE</b> Indoor unit Outdoor unit					NEW  FHQ71DAVMA RZQ71LV1	NEW  FHQ100DAVMA RZQ100HAY4A	NEW  FHQ125DAVMA RZQ125HAY4A	NEW  FHQ140DAVMA RZQ140HAY4A	Page 25	
<b>WALL MOUNTED TYPE</b> Indoor unit Outdoor unit							NEW  FAQ100CVEA RZQ100HAY4A			Page 27
<b>CEILING MOUNTED SLIM DUCT TYPE</b> Indoor unit Outdoor unit	 FDXS25CVMA RXS25EBVMA	 FDXS35CVMA RXS35EBVMA	 FDXS50CVMA RXS50FVMA	 FDXS60CVMA RXS60FVMA					Page 29	
<b>CEILING MOUNTED BUILT-IN TYPE</b> Indoor unit Outdoor unit			 FBQ50BV1A RXS50FVMA	 FBQ60BV1A RXS60FVMA					Page 30	
<b>DUCT CONNECTION MIDDLE STATIC PRESSURE TYPE</b> Indoor unit Outdoor unit					NEW  FBQ71EVE RZQ71LV1	NEW  FBQ100EVE RZQ100HAY4A	NEW  FBQ125EVE RZQ125HAY4A	NEW  FBQ140EVE RZQ140HAY4A	Page 31	
<b>OUTDOOR UNIT</b>  Outdoor unit					NEW  RZQ71LV1	NEW  RZQ100HAY4A	NEW  RZQ125HAY4A	NEW  RZQ140HAY4A	Page 33	
<b>OUTDOOR UNIT</b>  Outdoor unit	 RXS25EBVMA	 RXS35EBVMA	 RXS50FVMA	 RXS60FVMA						

# Daikin meets your needs with the line up of inverters for various types of indoor units and power supplies

CEILING MOUNTED CASSETTE TYPE <Round Flow>



COMPACT MULTI FLOW CEILING MOUNTED CASSETTE TYPE



WALL MOUNTED TYPE



CEILING MOUNTED SLIM DUCT TYPE

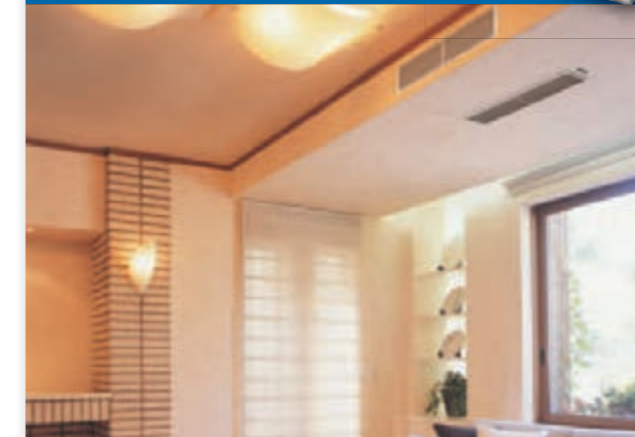
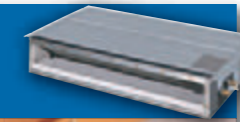

CEILING MOUNTED BUILT-IN TYPE

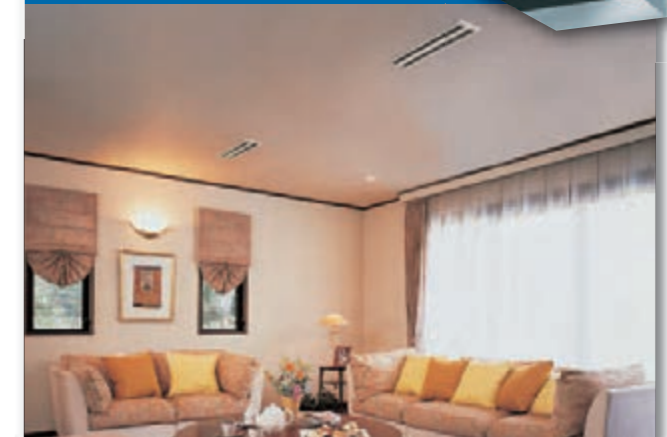

CEILING SUSPENDED TYPE



DUCT CONNECTION MIDDLE STATIC PRESSURE TYPE



# Cassette air conditioner with 360° uniform airflow sets the standard



**Option**  
Accessory required for indoor unit.

### Navigation Remote Controller

(Wired Remote Controller)



**BRC1E63**

Note: Remote controller cable is not included and must be procured locally.

### Wired LCD remote controller



**BRC2E61**

Note: Remote controller cable is not included and must be procured locally.

### Wireless LCD remote controller

A signal receiver must be added to the indoor unit.



Cooling only **BRC7F635F**

Heat pump **BRC7F634F**



Signal receiver unit (Installed type)

Wireless remote controller is supplied in a set with a signal receiver.

Avoids uneven temperature and discomfort caused by drafts

## Comfort enhanced by Round Flow!

### 360° airflow

- With uniform temperature distribution



Airflow distribution creates uniform comfort throughout the space.

Room remains comfortable even when set temperature is raised 1°C.

### Air movement is gentle with Round Flow

- Enhanced Comfort

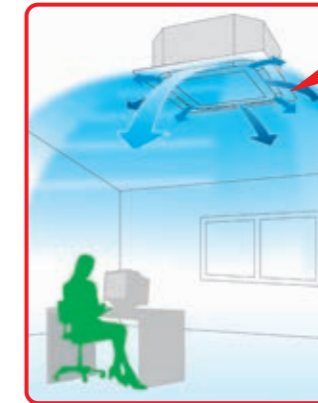

360° airflow can maintain comfort even if air discharge speed is lower.

Velocity decreases by 25% when set temperature is raised 1°C to 1.5°C.

## Adapts easily to the installation space

- Because air flows out from corner outlets, comfort spreads more widely

**Typical flow patterns** There are a total of 23 flow patterns.

All-round flow	3-way flow	L-shaped 2-way flow	Opposite 2-way flow
(E.g., installed in middle of ceiling) 4-way flow also possible.	(E.g., installed near a wall)	(E.g., installed in a corner)	(E.g., installed in a long room)

Note: Whatever the discharge direction, the same type of panel is used. If installing for other than all-round flow, an air discharge outlet sealing material (option) must be used to close each unused outlet.  
Operation sound increases when using 2-way or 3-way flow.

Grime prevention and antibacterial coating: Make cleaning easier

## External panels are treated with a coating that repels dirt

- To prevent dirt sticking to the external panels, they have been coated with a surface treatment

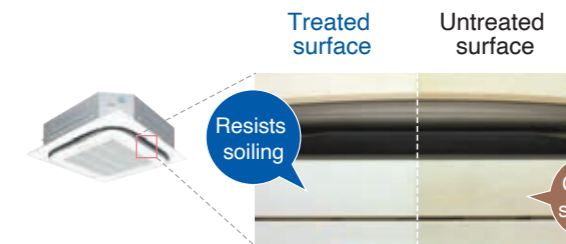

Condition after exposure to the smoke of 600 cigarettes in 1 m<sup>3</sup> enclosed space.

- Silver ion anti-bacterial drain pan

A built-in antibacterial treatment that uses silver ion in the drain pan prevents the growth of slime, bacteria, and mould that cause smells and clogging.

- Non-flocking flaps

Condensation does not easily form on and dirt does not cling to non-flocking flaps. It is easy to clean.

- Filter has anti-mould and antibacterial treatment

Prevents mould and microorganisms growing out of the dust and moisture that adheres to the filters.

**Unified square panels** **Compact body and quiet operation**

- Panel size is the same for all models, FCQ50-140KA. It is easy to maintain a neat appearance when multiple units are installed in the same room.

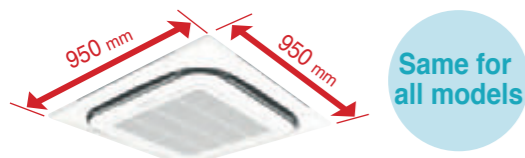

Indoor unit	Sound pressure level		
	High	Middle	Low
50KA	35	31.5	28
60KA	35	31.5	28
71KA	35	31.5	28
100KA	43	37.5	32
125KA	44	39	34
140KA	44	40	36

**Optimal comfort and convenience assured by 2 air discharge modes**

Air direction	Standard setting <sup>1</sup>	Setting to prevent soiling of ceiling <sup>2</sup> (field setting)
Desired situation	Standard setting to prevent draft.	Recommended for shops with light coloured ceilings that must be kept spotless.
Auto-swing	Auto-swing between 15° and 60°	Auto-swing between 25° and 60°
5-levels air direction setting	Settable to 5 different levels between 15° and 60°	Settable to 5 different levels between 25° and 60°
Draft prevention (In heating mode)	At heating startup and thermo OFF, air discharge is automatically set to a near horizontal 25° or 30° to prevent direct exposure to cool air drafts.	
Auto air direction control	The air direction is set automatically to the memorised position of the previous air direction.	

Note:  
<sup>1</sup>Air direction is set to the standard position when the unit is shipped from the factory. The position can be changed from the remote controller.  
<sup>2</sup>Closing of the corner discharge outlets is recommended.

**Suitable for high ceilings**

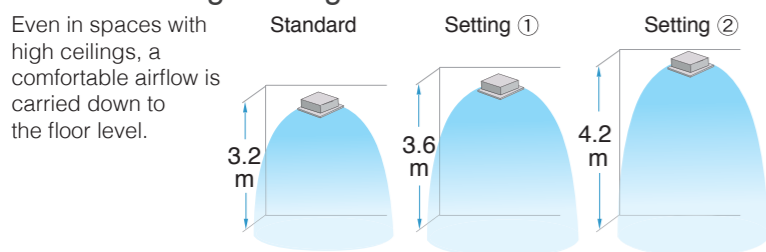

When all round flow is selected, ceilings up to 4.2 m in height can be accommodated. (100-140KA)

**Criteria for ceiling height and number of air discharge outlets** (Ceiling height is reference value)

Ceiling height	Standard	Number of air discharge outlets used							
		50-71KA				100-140KA			
		All round flow	4-way flow	3-way flow	2-way flow	All round flow	4-way flow	3-way flow	2-way flow
Standard	2.7 m	3.1 m	3.0 m	3.5 m	3.2 m	3.4 m	3.6 m	4.2 m	
High ceiling ①	3.0 m	3.4 m	3.3 m	3.8 m	3.6 m	3.9 m	4.0 m	4.2 m	
High ceiling ②	3.5 m	4.0 m	3.5 m	—	4.2 m	4.5 m	4.2 m	—	

Note: Factory settings are for standard ceiling height and all-round flow. High ceiling settings (1) and (2) are set with the remote controller by field setting.

- Two selectable temperature-sensors [See page 43](#)
- Switchable fan speed: High/Middle/Low  
Control of airflow rate has been improved from 2-step to 3-step.

**Quick and easy to install**

- Just 256 mm high. Installable in tight ceiling spaces (50-71KA)

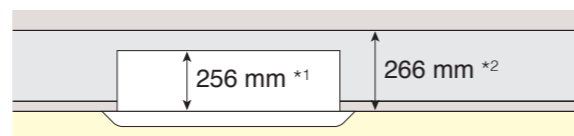

\*1 298 mm high with 100-140KA  
 \*2 308 mm high with 100-140KA

**Easy height adjustment**

Each corner of the unit has an Adjuster Pocket that lets you easily adjust the unit's suspended height.

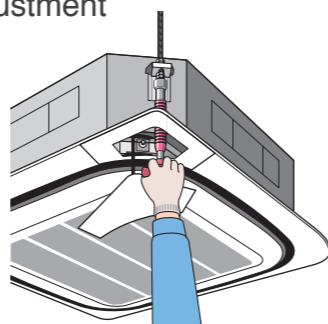

Note:  
 If the wireless remote controller is installed, a signal receiver unit is housed in one of the adjuster pockets.

- All models can be installed without using lifter because of the light weight

**Installed in any direction**

Since the orientation of the suction grille can be adjusted after installing, the direction of the suction grille lines can be unified when multiple units are installed.

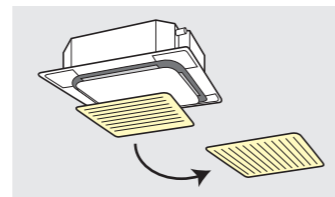

- Drain pump is equipped as standard accessory with 850 mm lift

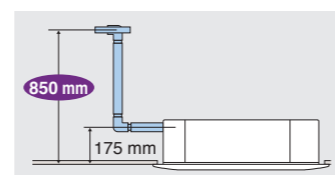

**Transparent drain socket**



- DIII-NET communication standard  
Connection to a centralised control system is available without option.
- Low gas pressure detection [See page 44](#)

**Easier to maintain**

- The condition of the drain pan and drain water can be checked by removing the drain plug and suction grille
- With Ultra long-life filters (option), maintenance is not required in normal shops or offices for up to four years

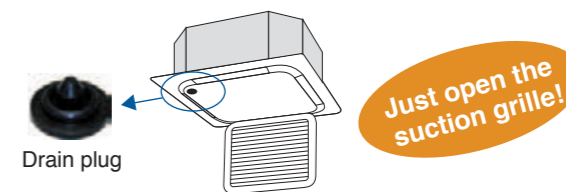

Options required for specific operating environments

**Ultra long-life filter unit**

Even in dusty environments where the air conditioning is on most of the time, the ultra long-life filter only has to be cleaned once a year.

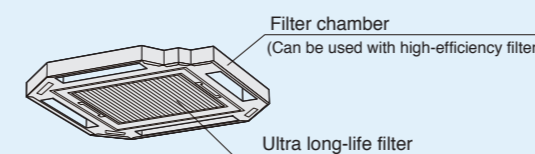

**Dusty area: annual filter change**

\*For dust concentration of 0.3 mg/m<sup>3</sup> (Requires separately sold Air purifier.)  
 1 year (Approx. 5,000 hr) ≈ 15 hr/day x 28 day/month x 12 month/year

**Ordinary store or office: filter change every 4 years**

\*For dust concentration of 0.15 mg/m<sup>3</sup>  
 4 years (Approx. 10,000 hr) ≈ 8 hr/day x 25 day/month x 12 month/years x 4 years

**High-efficiency filter unit**

Available in two types: 65% and 90% colorimetry.

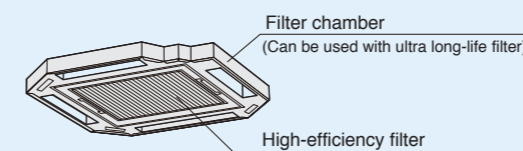

**Insulation kit for high humidity**

Please use if you think the temperature and humidity inside the ceiling exceeds 30°C and RH 80%, respectively.

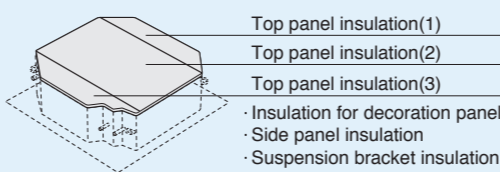

**Panel spacer**

Use when only minimal space is available between drop ceilings and ceiling slabs.

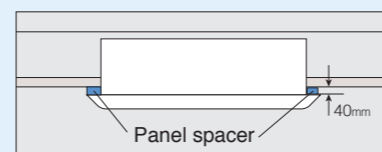

Note: Some ceiling constructions may hinder installation. Contact your Daikin Dealer before installing your unit.

**Sealing material of air discharge outlet**

Sealing material block air discharge openings not used in 2-way or 3-way blow.

**Branch duct (direct-connection round duct)**

A round duct can be attached without the need for a chamber. A flanged port for direct connection of a round duct is provided. An existing branch duct chamber can also be fitted (square slit hole).

**Fresh air intake kit** Note 1.2

Using this kit, a duct can be connected to take outdoor air in. There are two chamber types that have intake in two places: with T-duct joint and without T-duct joint.

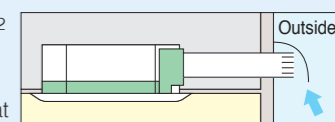

The units can be installed in the following different ways.

**Chamber type (without T-duct joint)** Note 3.4

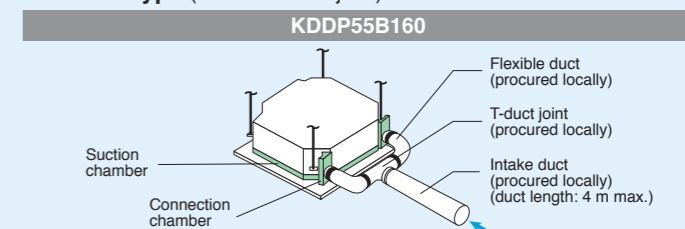

**Chamber type (with T-duct joint)** Note 3.4

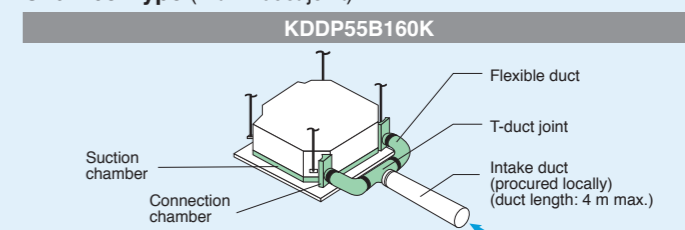

**Direct installation type**

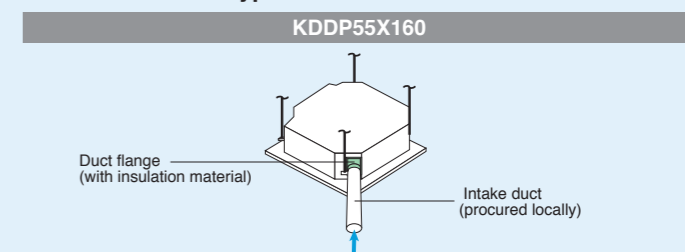

Note: 1 Use of options will increase operating sound.  
 2 Connecting ducts, fan, insect nets, fire dampers, air filters, and other parts should, as required, be procured locally.  
 3 When a local-procured fan is used, an interlock with air conditioner is necessary. Optional PCB(KRP1C63) is required for interlocking.  
 4 It is recommended that the volume of outdoor air introduced through the kit is limited to 10% of the maximum airflow rate of the indoor unit. Introducing higher quantities will increase the operating sound and may also influence temperature sending.

# Quiet decor-blending form and easy installation in new or old buildings



**Option**  
Accessory required for indoor unit.

**Navigation Remote Controller**  
(Wired Remote Controller)

**BRC1E63**

Note: Remote controller cable is not included and must be procured locally.

**Wired LCD remote controller**

**BRC2E61**

Note: Remote controller cable is not included and must be procured locally.

**Wireless LCD remote controller**  
A signal receiver must be added to the indoor unit.

Cooling only **BRC7E531W**  
Heat pump **BRC7E530W**

Signal receiver unit (Installed type)

Wireless remote controller is supplied in a set with a signal receiver.

## Compact

- Sized to fit inside 600mm wide ceiling grids

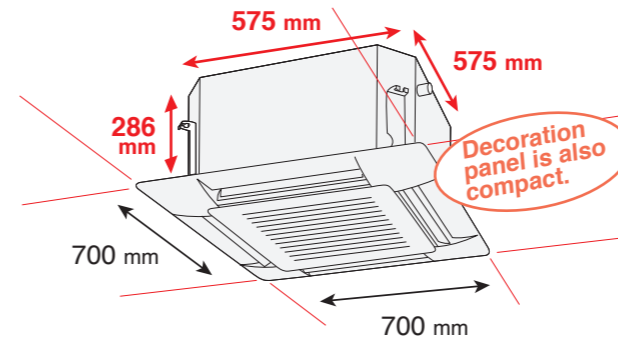

- Fits without the need to cut T-bar grid

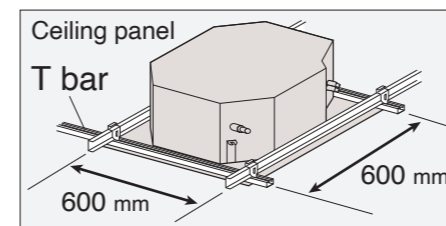

The control box is built in to the unit, so maintenance is possible by simply removing the grille. An inspection opening is not required even for modules other than 600 x 600.



## Quiet

- Quiet, but small-diameter fan

Quiet operation is achieved even with a compact body and developed spiral hub cover that reduces the static pressure inside the indoor unit.



Indoor unit	Sound pressure level	
	High	Low
25B	29.5	24.5
35B	32	25
50B	36	27
60B	41	32

dB(A)

## Comfortable

- Designed for low draft performance

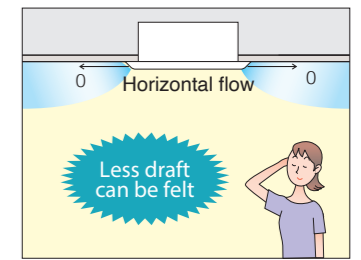

- Consistent comfort throughout

- Auto-swing operation distributes conditioned air more evenly.
- Airflow direction can be adjusted in accordance with room conditions.

	Auto-swing	5-levels air direction setting
Standard setting	Auto-swing between 0 and 60	Settable to 5 different levels between 0 and 60
Draft prevention setting (Set on site)	Auto-swing between 0 and 35	Settable to 5 different levels between 0 and 35
Setting to prevent soiling of ceiling (Set on site)	Auto-swing between 25 and 60	Settable to 5 different levels between 25 and 60

Note: This angle above is provided as a guide.

- Multi-Flow System

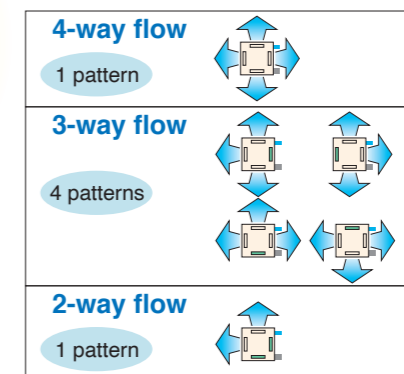

"■" denotes piping direction. ■ Drain piping  
"■" denotes sealing member for air discharge outlet (option).

Note: For 3-way or 2-way flow installation, the sealing member for air discharge outlet (option) must be used to close off the unused outlet(s).

- Air direction can be selected according to installation

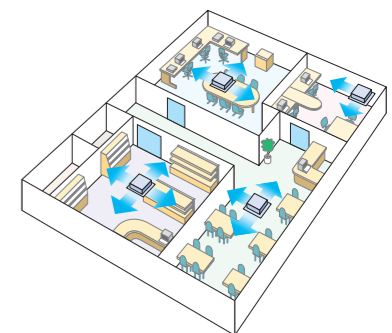

Note: Operation sound increases when using 2-way or 3-way flow.

- Two selectable temperature-sensors

Both indoor unit and wired remote controllers contain temperature-sensors. Temperature sensing can be set at the unit or, to further improve comfort level, closer to the target area at the wired remote control. This feature requires initial setting by the installer.

\*Temperature-sensor on indoor unit must be used when the air conditioner is controlled from another room.  
\*\*Wireless remote controller does not have a temperature-sensor.

- Switchable fan speed: High/Low

High setting provides maximum reach while low setting minimizes drafts.

- Drain pump is equipped as standard accessory with 750 mm lift

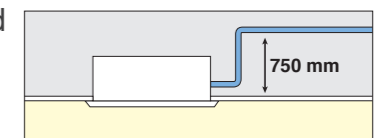

# Comfortable airflow travels throughout the room



**NEW**  
 FHQ50/60/71/100/125/140DA  
 FHQ35/50/60BV  
 FHQ50-140DA  
 FHQ35-60BV

**Option**  
 Accessory required for indoor unit.

**Navigation Remote Controller**  
 (Wired Remote Controller)  
**BRC1E63**  
 Note: Remote controller cable is not included and must be procured locally.

**Wired LCD remote controller**  
**BRC2E61**  
 Note: Remote controller cable is not included and must be procured locally.

**Wireless LCD remote controller**  
 A signal receiver must be added to the indoor unit.

FHQ35-60BV  
 Cooling only **BRC7EA66**  
 Heat pump **BRC7EA63W**

FHQ50-140DA  
 Cooling only **BRC7GA56**  
 Heat pump **BRC7GA53**

Signal receiver unit (Installed type)  
 Wireless remote controller is supplied in a set with a signal receiver.

## The latest stylish model (FHQ-DA)

- Sophisticated design  
 Flap neatly closes when not in use.
- White colour



## Comfortable

- The technology of the DC fan motor, wide sirocco fan, and large heat exchanger combine for greater airflow and quiet operation (FHQ-DA)
- Auto swing (up and down) and louvers (left and right by hand) bring comfort to the room
- Louver manually adjusts for straight or wide angle airflow

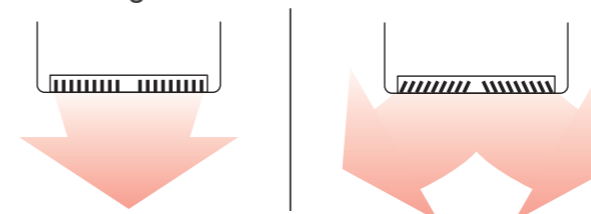

- Suitable for high ceilings

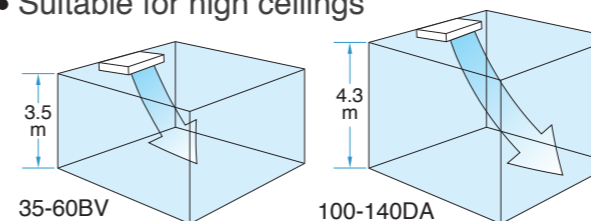

	35-60BV, 50-71DA	100DA	125/140DA
Standard	2.7m or less	3.8m or less	4.3m or less
High ceiling	2.7m~3.5m	3.8m~4.3m	—

Note: Factory settings is "standard".  
 "High ceiling" are set with remote controller by field setting.

- Two selectable temperature-sensors  
 See page 43
- Switchable fan speed:  
 High/Middle/Low (FHQ-DA)  
 High/Low (FHQ-BV)
- Programme "Dry" See page 43

## Installation flexibility for freedom of design

- Flexible installation  
 The unit fits more snugly into tight spaces.

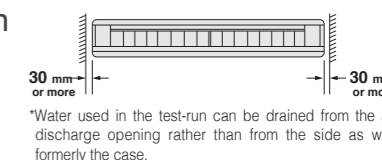

- Drain pump kit (option) can be easily incorporated

Drain pipe connection can be done inside the unit. Refrigerant and drain pipe outlets are at the same opening.

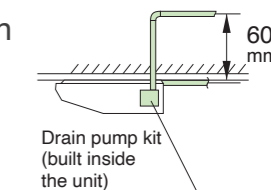

- DIII-NET communication standard (FHQ-DA)  
 Connection to a centralised control system is available without option.
- All wiring and internal servicing can be done from under the unit
- Easier piping work for rear side by removable frame (FHQ-DA)

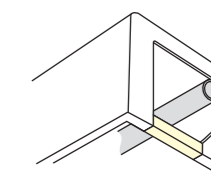

## Easy maintenance

- Drain pump kit (option) includes a silver ion antibacterial agent that assists in preventing the growth of slime, bacteria, and mould that cause smells and clogging
- Non-flocking flap  
 Condensation does not easily form on and dirt does not cling to non-flocking flap. It is easy to clean.
- Easy-clean, flat surfaces  
 It is easy to wipe dirt off the flat side and lower surfaces of the unit.

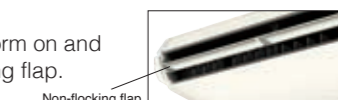

## Quiet operation

Indoor unit	Sound pressure level dB(A)		
	High	Middle	Low
35BV	37	—	32
50BV	38	—	33
60BV	39	—	33
50/60DA	37	35	32
71DA	38	36	34
100DA	42	38	34
125DA	44	41	37
140DA	46	42	38

## Oil resistant grille

- Oil-resistant plastic is used for the air suction grille. This satisfies durability in restaurants and other similar environments.  
 Note: Intended for use in salons, dining rooms, and ordinary sales floors, this specification is not suitable for kitchens or other harsh environments.

# Compact design and easy installation



**Option**  
Accessory required for indoor unit.

## Navigation Remote Controller



**BRC1E63**

Note: Remote controller cable is not included and must be procured locally.

## Wired LCD remote controller



**BRC2E61**

Note: Remote controller cable is not included and must be procured locally.

## Wireless LCD remote controller

A signal receiver must be added to the indoor unit.



Cooling only **BRC7EB519**  
Heat pump **BRC7EB518**



Signal receiver unit (Installed type)  
Wireless remote controller is supplied in a set with a signal receiver.

## Compact & Sophisticated design

- FAQ100

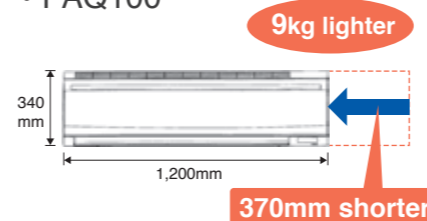

	FAQ100BV	FAQ100C
Height	360mm	340mm
Width	1,570mm	1,200mm
Depth	200mm	240mm
Weight	26kg	17kg

- Flaps neatly close when not in use
- Fresh white colour



## Comfortable

- Auto swing (up and down) and wide-angle louvers (left and right by hand) facilitate even room temperature

**Wide-angle louvers (by hand)**

Soft material louver bends airflow over a wider area

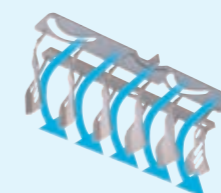

- An air discharge modes ensure comfortable air distribution across the entire room

**Auto-swing**

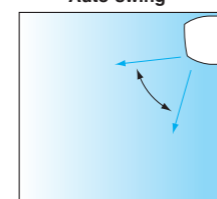

**5-level air direction setting**

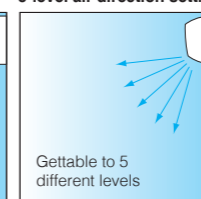

- Comfort even on the far side of the room

To carry air to the far side of long rooms, extra-high airflow adds 10% more fan speed the "high" setting. Air discharge strength is selected from the remote controller by field setting.

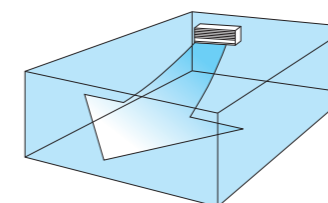

- Switchable fan speed: High/Middle/Low

- Auto airflow rate (When BRC1E63 is used)

- Programme "Dry"

Dehumidification is microprocessor controlled to prevent abrupt and uncomfortable changes in air temperature.

## Design and installation flexibility

- 6-direction refrigerant piping offers greater installation flexibility

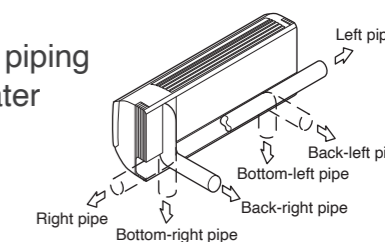

- Maintenance possible from the front of the unit

All maintenance tasks can be carried out via front access. During servicing, attachment and detachment of parts is easier.

- Drain pump kit is available as option

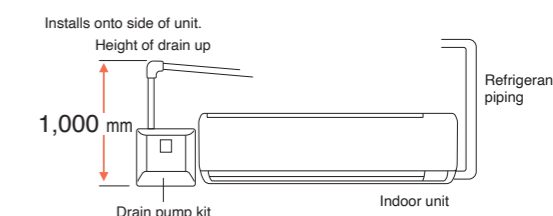

Drain pump kit can be installed on either left and right side of the indoor unit.



- Interlock control

As an energy saving feature, the room air conditioning unit can be interlocked with the key card system.

Using a 3rd-party building management system, air conditioning and lighting can be interlocked.

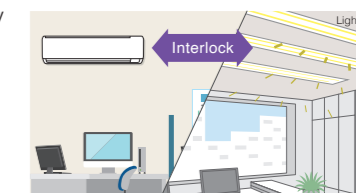

\* Field setting with remote controller

- DIII-NET communication standard

Connection to a centralised control system is available without option.

## Easy cleaning

- Removable and washable grille

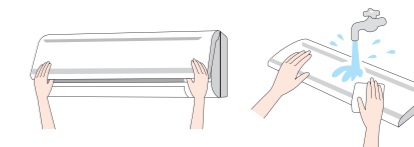

- Flat panel, easy to wipe dust off

- Non-flocking flaps

Condensation does not easily form on and dirt does not cling to non-flocking flaps. It is easy to clean.

# Suitable for tight ceiling spaces



Heat pump  
FDXS25/35/50/60CVMA

Note: Refer to Engineering data for airflow and External static pressure characteristics.

Option

Accessory required for indoor unit

Wired LCD remote controller  
BRC944B2

Note: 3 m (BRCW901A03) or 8 m (BRCW901A08) length wired remote controller cord is necessary.

Standard

Wireless LCD remote controller  
A signal receiver must be added to the indoor unit.

Heat pump ARC433B69

Signal receiver unit (Separate type)  
Wireless remote controller is supplied in a set with a signal receiver.

# Clever and compact mini ducted unit provides comfort and flexibility



Heat pump  
FBQ50/60BV1A

Option

Accessory required for indoor unit

Navigation Remote Controller  
(Wired Remote Controller)  
BRC1E63

Note: Remote controller cable is not included and must be procured locally.

Wired LCD remote controller  
BRC2E61

Note: Remote controller cable is not included and must be procured locally.

Wireless LCD remote controller  
A signal receiver must be added to the indoor unit.

Heat pump BRC4C62

Signal receiver unit (Separate type)  
Wireless remote controller is supplied in a set with a signal receiver.

## Smooth Finish

- The only visible sign of these unobtrusive units is their discharge grilles. They fit completely inside the ceiling to maintain the original decor of a room. Each unit comes with its own wireless remote controller.

## Slim Profile

- All units share the same low height of just 200 mm. This means it is now possible to install a unit inside a shallow ceiling cavity with a height of just 240 mm.

## Comfortable

- Quiet operation

Indoor unit	Sound pressure level dB(A)	
	High	Low
25C	35	31
35C	35	31
50C	37	33
60C	38	34

## Comfortable

- Flexibly adapts to shop interiors

To cope with the challenges of L-shaped or U-shaped spaces, it is possible to install the air discharge unit away from the main unit. At the same time, different types of architectural space can be kept comfortable.

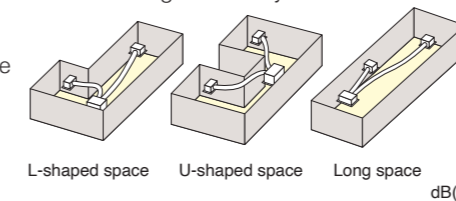

- Quiet operation

Indoor unit	Sound pressure level dB(A)	
	High	Low
50B	33	29
60B	34	30

## Compact

- Compact design of built-in type helps blend with interior decor.  
Height reduced to allow installation in confined spaces.

## Work & Servicing

- The height of the unit is a mere 300 mm. It can be installed in a narrow ceiling space. (when access panel is used.)

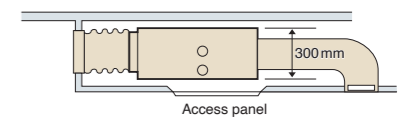

- Provided with condensate drain pump, waking drain piping easier in awkward spaces.

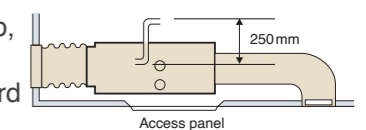

- External static pressure can be set depending on duct length, presence of high-efficiency filter, and other installation conditions.

External static pressure pattern (Pa)

Indoor unit	High	Standard	Low
50B-60B	88	49	20

External static pressure is set to standard when the unit is shipped from the factory.



# Thinner design allows greater installation flexibility



**NEW**  
FBQ50/60/71/100/125/140E

**Option**  
Accessory required for indoor unit.

**Navigation Remote Controller**  
(Wired Remote Controller)

**BRC1E63**

Note: Remote controller cable is not included and must be procured locally.

**Wired LCD remote controller**

**BRC2E61**

Note: Remote controller cable is not included and must be procured locally.

**Wireless LCD remote controller**  
A signal receiver must be added to the indoor unit.

Cooling only **BRC4C66**  
Heat pump **BRC4C65**

Signal receiver unit (Separate type)

Wireless remote controller is supplied in a set with a signal receiver.

## Design and installation flexibility

- With a height of only 245 mm, installation is possible even in buildings with narrow ceiling spaces



One of the industry's most compact bodies in the mid-static pressure range.

Indoor unit	50/60/71E	100/125/140E
Height (mm)	245	
Width (mm)	1,000	1,400
Depth (mm)	800	

- Higher lift is realized by utilising built-in DC drain pump with standard accessory

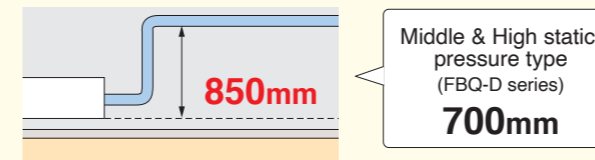

- Bottom suction is available

Wiring and servicing can be done from the underside of the unit (an option part required).

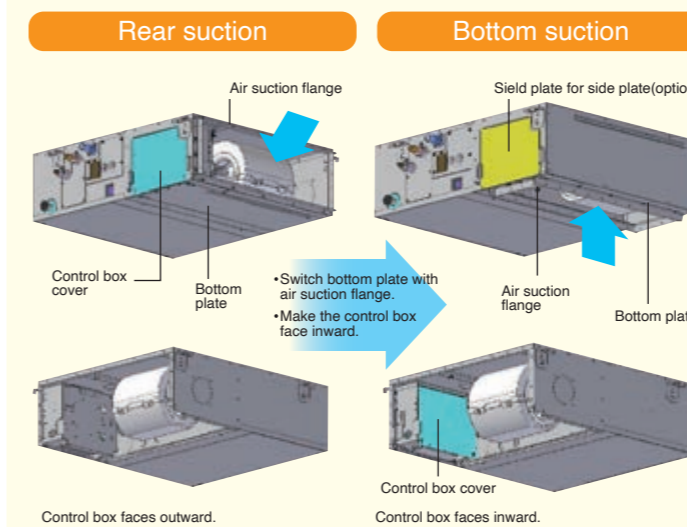
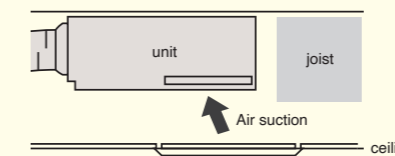

- Using a DC fan motor, the external static pressure can be controlled to within a range of 50 Pa to 150 Pa

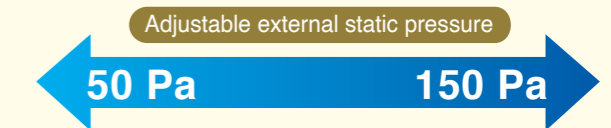

Set to low static pressure when ducts are short.

Set to high static pressure for advanced needs such as when using dampers and long ducts.

Comfort airflow is achieved in accordance with conditions such as duct length.

- Airflow rate auto adjustment function

Controls the airflow rate using a remote controller during test run. It is automatically adjusted to approximately  $\pm 10\%$  of the rated H tap airflow.

- Interlock control

As an energy saving feature, the room air conditioning unit can be interlocked with the hotel key card system.

Using a 3rd-party building management system, air conditioning and lighting can be interlocked.

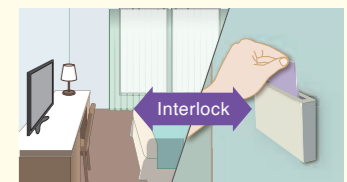

\* Field setting with remote controller

- DIII-NET communication standard

Easier communication and connection with the centralised control system.

## Easy maintenance

- Position of drain pan inspection opening has been modified for easier inspection work

- Drain pan maintenance check window

This makes it possible to inspect for drain pan dirt and to confirm drainage during installation without the use of tools.

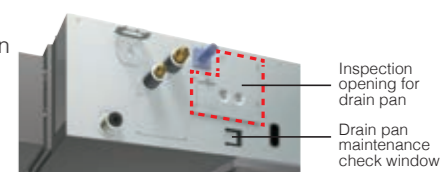

- Easy maintenance because the drain pan can be removed

## High efficiency

- DC fan motor and DC drain pump are utilised to improve energy efficiency

### Simultaneous air conditioning of two rooms and ventilation grille (ventilation opening)

When air conditioning two rooms simultaneously, the air discharged into each room must be circulated back to the air conditioner. To achieve this, a ventilation duct should be installed for each room or one of the indicated ventilation grilles should be installed on the partitioning wall or under the door between the rooms.

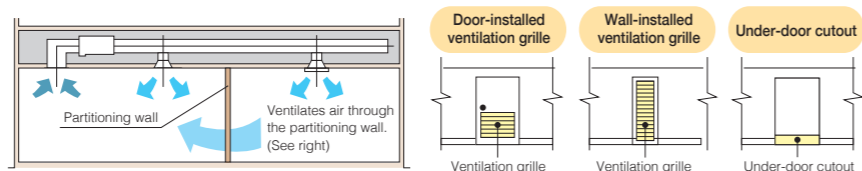

Note: The under-door cutout method should be used only when there is a small volume of airflow.

## Comfort

- Switchable fan speed: High/Middle/Low and Auto ("Auto" is applicable when BRC1E62 is used.)

## Clean

- Silver ion anti-bacterial drain pan

A built-in antibacterial treatment that uses silver ion in the drain pan prevents the growth of slime, bacteria, and mould that cause smells and clogging.

**Super Inverter**

# Compact Outdoor unit



## Easy installation and maintenance

- Pre charged for up to 30 metres  
If the refrigerant piping length does not exceed 30 m, there is no need for on-site gas charging.
- 4-direction piping offers greater layout freedom (RZR100-140 and RZQ series)  
The outer panel for the piping connection part of the front, right side and backside can be removed and is easier for post-installation piping work.

### Long piping length

#### Allowed refrigerant piping length and level difference

	RZR RZQ71L	RZQ100-140
Pre charged <sup>1</sup>	30 m	
Max. length	50 m (Equivalent length 70m)	75 m (Equivalent length 90m)
Max. level difference	30 m	

Note : <sup>1</sup>Additional refrigerant charging is required if the refrigerant pipe is longer than the length.

- Removable part of bottom frame makes the piping work easier

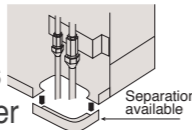

- Facilitates pump down (Refrigerant recovery function)

A pump-down switch is provided to make it easier to collect refrigerant if the unit is to be moved or layout modified.

\*Pump-down function is available for pre-charged refrigerant amount.

- Low gas pressure detection function  
Effective gas monitoring reduces the labor required for operation, maintenance, and repairs.

## Durability

- As the bottom frame is subject to corrosion, a corrosion-proof galvarium steel plate is adopted to enhance the durability
- Heat exchange fins are provided with anti-corrosion treatment (RZR50-71 and RZQ series)

### Construction

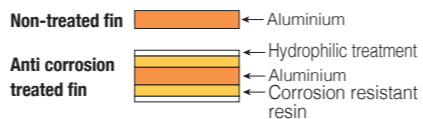

## Demand Control Function

- By setting limits that restrict power consumption, you can cut electricity bills (RZR100-140 and RZQ series)

Maximum power use is maintained within a set level of system capacity. This enables effective demand control while maintaining comfort. Maximum power consumption can be set at 40, 60, 70, 80, or 100%.

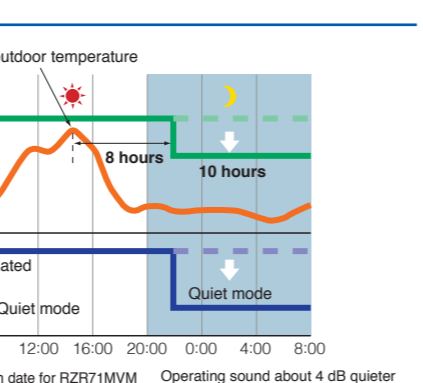
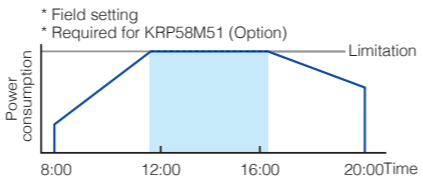

## Compact and lightweight

Reduced installation work thanks to light, compact outdoor unit.

### Comparison of outdoor units

	RR140MY1	NEW RZR140MYM
Height	1,345 mm	990 mm
Weight	108 kg	73 kg

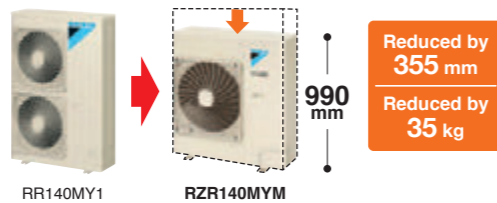

## Night quiet operation mode

- The Automatic night quiet mode will initiate 8 hours after the peak temperature is reached in the daytime, and normal operation will resume 10 hours after that

★ Reducing noise will reduce capacity slightly.

Cooling only	Heat pump	Sound pressure level <sup>1</sup> (dB(A))	
		Rated <sup>2</sup>	Night Quiet Mode
RZR50/60/71MVM	—	48	44
RZR100MYM	RZQ71L/100HA	49	45
—	RZQ125HA	50	45
—	RZQ140HA	50	46
RZR125MYM	—	52	45
RZR140MYM	—	54	45

Note : <sup>1</sup>Anechoic chamber conversion value, measured according to JIS parameters and criteria. During operation these values are somewhat higher owing to ambient conditions. <sup>2</sup>Value when cooling. Value will differ when heating.

Note : Daikin data for RZR71MVM Operating sound about 4 dB quieter

# Technology for energy efficiency

## The high efficiency compressor to achieve a high COP

### 1 Compressor equipped with Reluctance DC motor

Daikin DC Inverter models are equipped with the Reluctance DC motor for compressor. The Reluctance DC motor uses 2 different types of torque, neodymium magnet\*1 and reluctance torque\*2. This motor can save energy because it generates more power with a smaller electric power than an AC or previous DC motor.

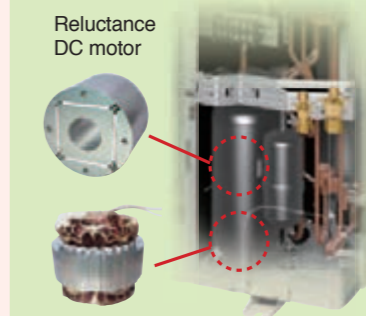
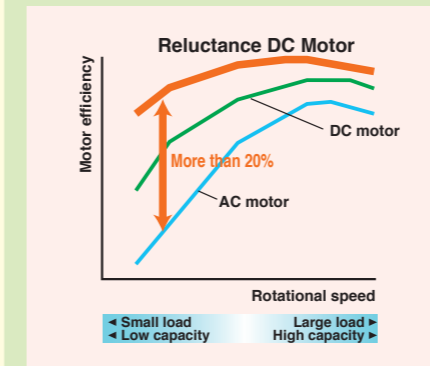

\*1. A neodymium magnet is approximately 10 times stronger than a standard ferrite magnet. \*2. The torque created by the change in power between the iron and magnet parts.



### RZR50-140M, RZQ71L

#### >> Swing compressor

Energy savings is realised, eliminating the friction and the leakage of refrigerant gas.

### RZQ100-140HA

#### >> Scroll compressor

Sucked gas is compressed in the scrolling part before the heated motor, so that the machine compress the non-expanded gas, resulting in high efficiency compression.

### 2 Fan

#### V-cut Propeller Fan (RZR50-71M)

Through use of a V-cut propeller fan that imitates the efficiency of the swan, a migratory bird, airflow becomes smooth and loss is reduced.

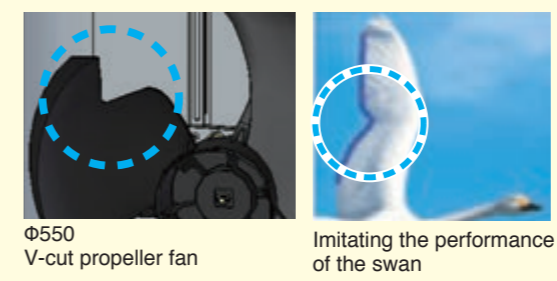

#### Aero Spiral Fan (RZR100-140M, RZQ series)

The Aero Spiral Fan features fan blades with the bent blade edges, further reducing turbulence.

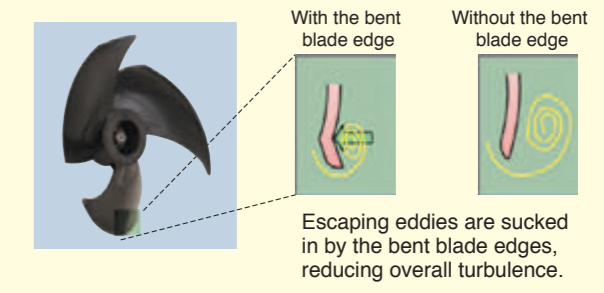

### 3 DC fan motor

Efficiency improved in all areas compared to AC motors, especially at low speeds.

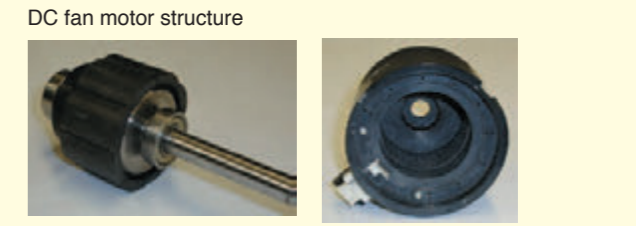

# Easy-to-read LCD remote controller allows various system control configurations and can control multiple indoor units.

Remote controller options are shown on the page introducing each indoor unit model.

## Navigation Remote Controller (Wired LCD Remote Controller)

**NEW**



BRC1E63

This simple, modern designed remote controller with fresh white colour matches your interior design. Operation is much easier and smoother, just follow the indications on the navigation remote controller.

### Clear Display

#### Dot matrix display

A combination of fine dots enables various icons. Large text display is easy to see.

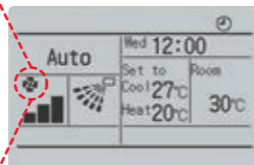
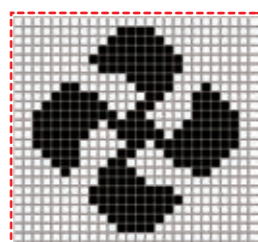

#### Backlight display



### Energy saving

#### **NEW** Setpoint auto reset

- Even if the set temperature is changed, after a preset period new set temperature returns to preset value.
- Period selectable from 30, 60, 90, or 120 min.

#### Restaurant example

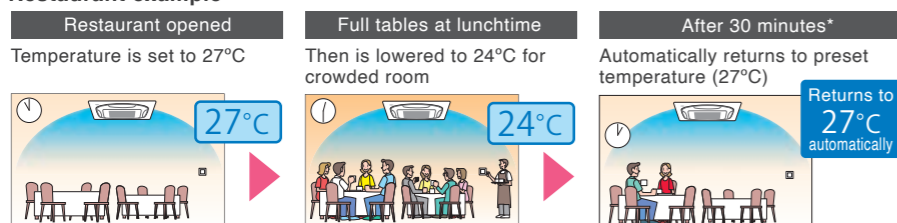

#### **NEW** Setpoint range set

- Saves energy by limiting the min. and max. set temperature.
- Avoids excessive heating or cooling.
- This function is convenient if the remote controller is installed where anyone can change the settings.

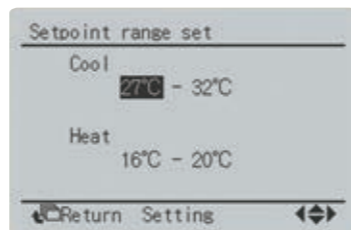

#### Off timer (programmed)

- Sets and saves setting for an increment of time that automatically turns off air conditioner after a preset period of time for each time operation starts.
- Period can be preset from 30 to 180 minutes in 10-minute increments.

### Convenience

#### Weekly schedule

- 5 actions per day can be scheduled for each day of the week.
- The holiday function will disable schedule timer for the days that have been set as holiday.

**NEW** - 3 independent schedules can be set. (e.g. summer, winter, mid-season)

Schedule nr 1				
	Time	Act	Cool	Heat
Mon	8:30	ON	25°C	—
	10:00	OFF	—°C	—°C
	13:00	ON	25°C	—
	15:00	OFF	—°C	—°C

#### Multilingual display

Display is available in 11 languages.

(English, German, French, Spanish, Italian, Portuguese, Greek, Dutch, Russian, Turkish, and Polish).

### Wired LCD remote controller

Easy operation with new intuitive design.



BRC2E61

- Simple operation with the use of six buttons. Users have direct access to basic functions and can easily set their preferred comfort.
- Intuitive design with the use of pictograms and user-friendly interface
- Compact size with measurements of 85 x 85 x 19mm.

### Wired remote controller has built-in temperature-sensor

(Applies to wired remote controllers (BRC2E61/BRC1E63))

- Enables temperature sensing closer to target area for improved comfort. (When using remote control from another room, temperature-sensor in indoor unit's air inlet must be selected.)

### Facilitates maintenance and repair

- All initial settings can be set from the remote controller. After interior construction is complete, ceiling mounted cassette type can be remotely set without having to use stepladder access for manual setting.

Setting contents: High ceiling use, air direction, filter type, address for centralised control (group control address is set automatically).

- Remote controller is equipped with model name and failure display functions. This facilitates service in the unlikely event of a malfunction. (Model name display function applies to BRC1E63 only.)

### Wireless LCD remote controller



Wireless remote controller



Signal receiver unit (For ceiling mounted cassette type)

- The wireless remote controller is supplied in a set with a signal receiver.
- Signal receiver unit is contained inside decoration panel or indoor unit.
- Shape of signal receiver unit differs according to the indoor unit.

Note: The signal receiver unit shown in the photograph is for mounting inside the decoration panel of the ceiling mounted cassette type.

### SkyAir shares common control with Heat Reclaim Ventilator and the other Daikin air-conditioning units, thus simplifying interlocking operations.

- Easily adaptable to large-scale, high-function, centralised remote control systems. Installing and connecting control wiring between SkyAir and other Daikin air-conditioning equipment is easy.

### Wireless remote controller for each indoor unit type

	Cooling only	Heat pump
CEILING MOUNTED CASSETTE TYPE	BRC7F635F	BRC7F634F
COMPACT MULTI FLOW TYPE	BRC7E531W	BRC7E530W
CEILING SUSPENDED TYPE	35-60BV	BRC7EA66
	50-140DA	BRC7GA56
WALL MOUNTED TYPE	BRC7GA53	BRC7EA63W
	BRC7EB519	BRC7EA53
CEILING MOUNTED SLIM DUCT TYPE	—	BRC7EB518
		ARC433B69 (Standard accessory)
CEILING MOUNTED BUILT-IN TYPE	—	BRC4C62
DUCT CONNECTION MIDDLE STATIC PRESSURE TYPE	BRC4C66	BRC4C65

### LCD panel shows operating status in letters, numbers, and motion.

- Airflow / swing display** Displays auto-swing operating status and setting position of air discharge angle.
- Preset temperature / operation mode display** Displays preset room temperature and operating status (fan, dry, cool).
- Programming time display** Operation start and stop time can be set for individual timers up to 72 hours. The LCD also shows when it is time to clean the filter, when changeover is under centralised control, and ventilation/cleaning.
- Self-diagnosis function** Monitors operating status within the system covering 40 items, and displays a message to indicate as soon as a malfunction occurs.

### System variation to control multiple indoor units

	Control pattern	Wired remote controller	Wireless remote controller
<b>Control by 1 remote controller</b>	(Basic system)	 ● Non-polar, double-core (max. wiring length 500 m)	 ● Signal receiver unit installed on indoor unit
<b>Control by 2 remote controllers</b>	For control from 2 locations such as in room and control room, exits, etc.	 ● Connects 2 wired remote controllers (See note 1)	 ● Control by 1 wireless remote controller and 1 wired remote controller (See note 2, 3) ● Signal receiver unit installed on indoor unit
<b>Group control</b>	For simultaneous control of up to 16 indoor units.	 ● Automatic address setting function	 ● Automatic address setting function ● Signal receiver unit installed on 1 indoor unit
<b>Control by external command</b>	Operation and monitoring is carried out using the contact signal from the operation control box in the monitoring room.	 (Command from outside) ● Optional wiring adaptor for electrical appendices is necessary	 (Command from outside) ● Optional wiring adaptor for electrical appendices is necessary
<b>Centralised remote control</b>	Centralised control of up to 64 indoor groups from remote location up to 1 km away.	 Central remote controller (option) ● Interface adaptor for SkyAir series (option) is required (See note 4)	 Central remote controller (option) ● Interface adaptor for SkyAir series (option) is required (See note 4)
<b>Interlock control with Heat Reclaim Ventilator</b>	Link by remote controller group control.	 Heat Reclaim Ventilator ● Can be operated simultaneously or independently by remote controller (set by ventilation mode)	 Heat Reclaim Ventilator ● Can be operated simultaneously by remote controller (set by ventilation mode)
	Zone link control by centralised control.	 Central remote controller (option) Heat Reclaim Ventilator ● Heat Reclaim Ventilator for indoor units within a zone are operated by interlocking. Can also be operated independently by remote controller.	 Central remote controller (option) Heat Reclaim Ventilator ● Heat Reclaim Ventilator for indoor units within a zone are operated by interlocking.

Note: <sup>1</sup>BRC1E62 can connect to BRC1E63 only. <sup>2</sup>It is not possible to use two wireless remote controllers. <sup>3</sup>BRC1E63 cannot connect to wireless remote controller. <sup>4</sup>The ceiling mounted cassette type <Round Flow>, ceiling suspended type (50-140DA), wall mounted type, and duct connection middle static pressure type come standard with an interface adaptor for SkyAir series.

# Whatever your space, give it the comfort it deserves

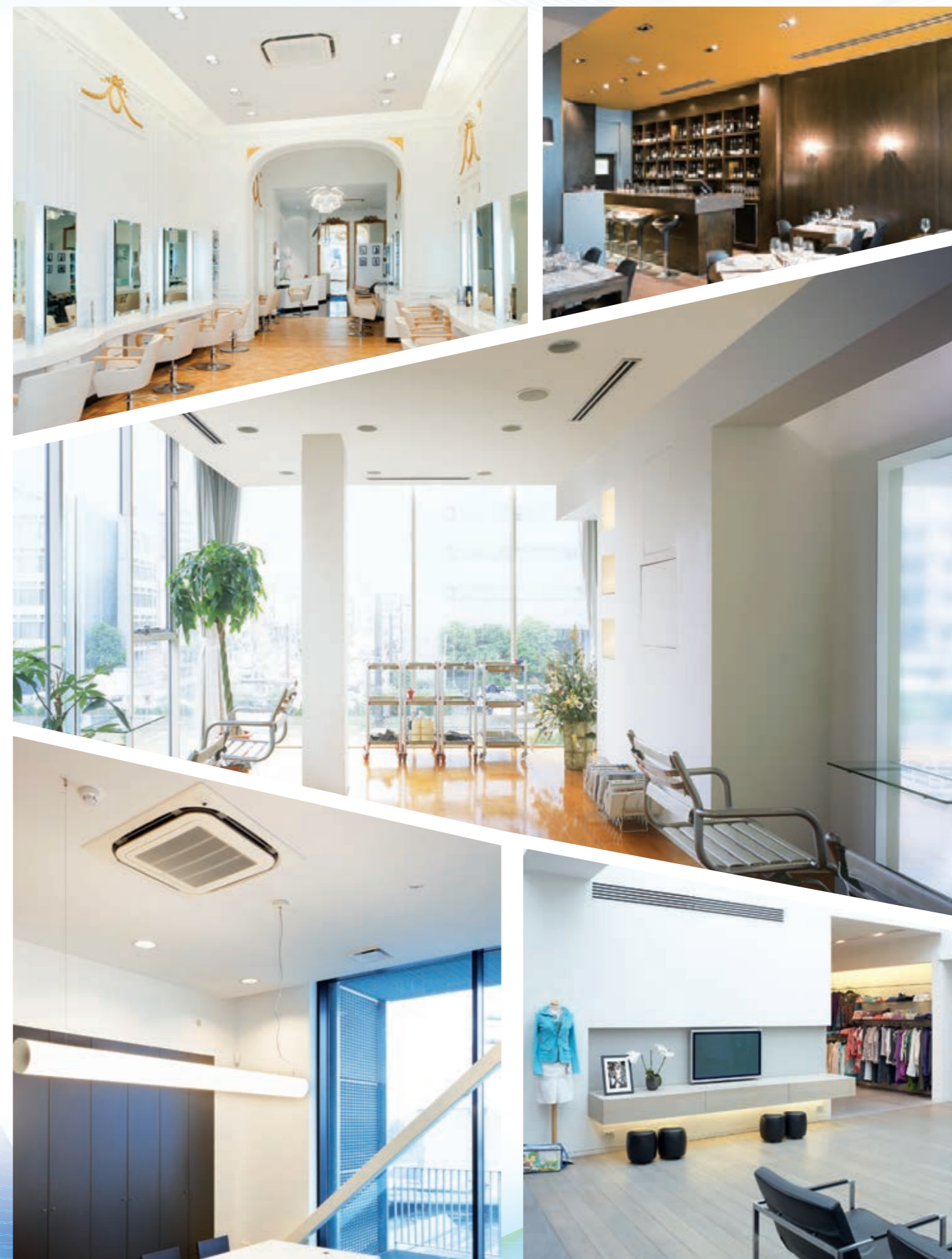

### Easily adaptable to large-scale, high-function, centralised remote control system.

#### Central remote controller

DCS302CA61 (Option)



Centralised control, with setting as simple as it is with a standard remote controller, of up to 64 groups (1,024 indoor units) is possible.

#### Unified on/off controller

DCS301BA61 (Option)



Centralised control of on/off by group or all at once for up to 256 indoor units.

#### Schedule timer

DST301BA61 (Option)



Unified control of weekly schedule for up to 1,024 indoor units. Schedule timer sets on/off time in 1 minute units to be executed twice a day for a week at a time.

#### Intelligent Controller

DCS601C51 (Option)



With its high functionality, the full colour "all-in-one" graphic controller facilitates management of SkyAir System in a variety of ways.

#### Interface adaptor for SkyAir series







DTA112BA51 (Option)

Enables centralised control via connection to a high-speed, DIII-NET communication system, adopted for the Daikin VRF system. Necessary for interface adaptor for SkyAir series with the central remote control units shown at above.

● The interface adaptor for the SkyAir series is optional except for the ceiling mounted cassette type <Round Flow>, ceiling suspended type (50-140DA), wall mounted type, and duct connection middle static pressure type.

# Functions overview

Cooling only

		CEILING MOUNTED CASSETTE TYPE (Round Flow)	COMPACT MULTI FLOW CEILING MOUNTED CASSETTE TYPE	CEILING SUSPENDED TYPE		WALL MOUNTED TYPE	DUCT CONNECTION MIDDLE STATIC PRESSURE TYPE
							
Indoor unit		FCQ50-140KAVEA	FFQ25-60BV1B	FHQ35BVV1B	FHQ50-140DAVMA	FAQ100CVEA	FBQ50-140EVE
Outdoor unit		RZR50-71MVM RZR100-140MYM	RKS25/35EBVMA RKS50/60FVMA	RKS35EBVMA	RZR50-71MVM RZR100-140MYM	RZR100MYM	RZR50-71MVM RZR100-140MYM
Comfort	Auto swing	●	●	●	●	●	
	Swing pattern selection	●	●				
	Draft prevention function (heating)						
	Independent up-and-down airflow						
	DC fan motor (Indoor unit)	●			●	●	●
	Switchable fan speed	● 3step	● 2step	● 2step	● 3step	● 3step	● 3step
	Auto airflow rate					● *1	● *1
	High fan speed mode					●	
	Programme "Dry"	●	●	●	●	●	●
	High ceiling application	●		● *5	● *5		
	Two selectable temperature-sensors *2	●	●	●	●	●	●
	Year-round cooling applicable		● *6	● *6			
Night quiet operation *3	●				●	●	
Remote Controller	Setpoint auto reset *1	●	●	●	●	●	●
	Setpoint range set *1	●	●	●	●	●	●
	Weekly schedule timer *1	●	●	●	●	●	●
	Off timer (programmed) *1	●	●	●	●	●	●
	On/Off timer *4	●	●	●	●	●	●
Cleanliness	Anti-bacterial air filter	●	●	●	●		● *7
	Mould-proof air filter					●	
	Silver ion anti-bacterial drain pan	●					●
	Mould-proof drain pan		●				
Work & servicing	Drain pump mechanism	●	●	● *7	● *7	● *7	●
	Pre-charged for up to 30 m *3	●			●	●	●
	Pre-charged for up to 10 m *3		●	●			
	Long-life filter	●	●	●	●		● *7
	Filter sign	●	●	●	●	●	●
	Ceiling soiling prevention	●	●				
	Low gas pressure detection *3	●			●	●	●
	Emergency operation	●			●	●	●
Self-diagnosis function	●	●	●	●	●	●	
Control features	Auto-restart	●	●	●	●	●	●
	Control by 2 remote controllers	●	●	●	●	●	●
	Group control by 1 remote controller	●	●	●	●	●	●
	External command control	● *7	● *7	● *7	● *7	● *7	● *7
	Central remote control	●	● *7	● *7	●	●	●
	Interlock control with Heat Reclaim Ventilator	●	●	●	●	●	●
	DIII-NET communication standard	●			●	●	●
Options	High-efficiency filter	●					●
	Ultra long-life filter	●					
	Fresh air intake kit	●	●		●		
Others	Anti corrosion treated heat exchangers *3	● *8	●	●	● *8	● *8	

Note: \*1 : Applicable when BRC1E63 is used  
 \*2 : Applicable when wired remote controller is used  
 \*3 : For outdoor units









\*4 : Applicable when BRC2E61 is used  
 \*5 : Installable on max. 3.5 m(35-71) and 4.3 m (100-140) high ceiling  
 \*6 : Applicable when outdoor temperature is from 10 to 46°CDB

\*7 : Option  
 \*8 : RZR50-71 only

# Functions overview

Heat pump

Indoor unit  
Outdoor unit

		CEILING MOUNTED CASSETTE TYPE (Round Flow) 	COMPACT MULTI FLOW CEILING MOUNTED CASSETTE TYPE 	CEILING SUSPENDED TYPE 		CEILING SUSPENDED TYPE 	CEILING MOUNTED SLIM DUCT TYPE 	CEILING MOUNTED BUILT-IN TYPE 	WALL MOUNTED TYPE 	DUCT CONNECTION MIDDLE STATIC PRESSURE TYPE 
		FCQ71-140KAVEA	FFQ25-60BV1B	FHQ35/50/60BVV1B		FHQ71-140DAVMA	FDXS25-60CVMA	FBQ50/60BV1A	FAQ100CVEA	FBQ71-140EVE
		RZQ71LV1 RZQ100-140HAY4A	RXS25/35EBVMA RXS50/60FVMA	RXS35EBVMA RXS50/60FVMA		RZQ71LV1 RZQ100-140HAY4A	RXS25/35EBVMA RXS50/60FVMA	RXS50/60FVMA	RZQ100HAY4A	RZQ71LV1 RZQ100-140HAY4A
<b>Comfort</b>	Auto swing	●	●	●		●			●	
	Swing pattern selection	●	●							
	Draft prevention function (heating)	●	●	●		●			●	
	Independent up-and-down airflow									
	DC fan motor (Indoor unit)	●				●			●	●
	Switchable fan speed	● 3step	● 2step	● 2step		● 3step	● 2step	● 2step	● 3step	● 3step
	Auto airflow rate						●		● *1	● *1
	High fan speed mode								●	
	Programme "Dry"	●	●	●		●	●	●	●	●
	High ceiling application	●		● *5		● *5				
	Two selectable temperature-sensors *2	●	●	●		●		●	●	●
	Hot start	●	●	●		●	●	●	●	●
Year-round cooling applicable	●	● *6	● *6		●	● *6	● *6	●	●	
Night quiet operation *3	●				●			●	●	
<b>Remote Controller</b>	Setpoint auto reset *1	●	●	●		●		●	●	●
	Setpoint range set *1	●	●	●		●		●	●	●
	Weekly schedule timer *1	●	●	●		●		●	●	●
	Off timer (programmed) *1	●	●	●		●		●	●	●
	On/Off timer *4	●	●	●		●		●	●	●
<b>Cleanliness</b>	Anti-bacterial air filter	●	●	●		●				● *7
	Mould-proof air filter						●		●	
	Silver ion anti-bacterial drain pan	●								●
	Mould-proof drain pan		●					●		
<b>Work &amp; servicing</b>	Drain pump mechanism	●	●	● *7		● *7		●	● *7	●
	Pre-charged for up to 30 m *3	●				●			●	●
	Pre-charged for up to 10 m *3		●	●			●	●		
	Long-life filter	●	●	●		●				● *7
	Filter sign	●	●	●		●		●	●	●
	Ceiling soiling prevention	●	●							
	Low gas pressure detection *3	●				●			●	●
	Emergency operation	●				●			●	●
Self-diagnosis function	●	●	●		●	●	●	●	●	
<b>Control features</b>	Auto-restart	●	●	●		●	●	●	●	●
	Auto-cooling/heating change-over	●	●	●		●	●	●	●	●
	Control by 2 remote controllers	●	●	●		●		●	●	●
	Group control by 1 remote controller	●	●	●		●		●	●	●
	External command control	● *7	● *7	● *7		● *7		● *7	● *7	● *7
	Central remote control	●	● *7	● *7		●	● *7	● *7	●	●
	Interlock control with Heat Reclaim Ventilator	●	●	●		●		●	●	●
DIII-NET communication standard	●				●			●	●	
<b>Options</b>	High-efficiency filter	●								●
	Ultra long-life filter	●								
	Fresh air intake kit	●	●			●				
<b>Others</b>	Anti corrosion treated heat exchangers *3	●	●	●		●	●	●	●	●

Note: \*1 : Applicable when BRC1E63 is used  
 \*2 : Applicable when wired remote controller is used  
 \*3 : For outdoor units

\*4 : Applicable when BRC2E61 is used  
 \*5 : Installable on max. 3.5 m(35-71) and 4.3 m (100-140) high ceiling  
 \*6 : Applicable when outdoor temperature is from 10 to 46°CDB

\*7 : Option  
 \*8 : RZR50-71 only

# Abundance of functions that provide comfortable air-conditioning in stores and offices.

•Note: Some features only available on selected models. See overview pages for full list of features applicable to each unit.

## Comfort

### Auto-swing

Delivers comfortable air-conditioning to all areas, near to and far from the air-conditioner. ■ The air flow direction can be fixed at your desired angle by the remote controller.

### Swing pattern selection

You can freely set air discharge settings by remote controller.

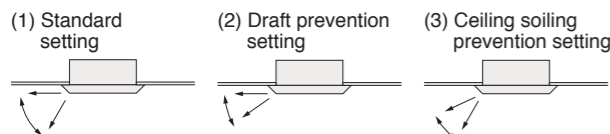

### Draft prevention function (heating)

To prevent cold air drafts, automatically adjusts airflow to near horizontal position when heating initially starts or when the thermo off.

### Independent up-and-down airflow

Independently adjust (manually) the eight horizontal blade louvers in both up and down directions to achieve an airflow that reduces uneven room temperature.

### DC fan motor (indoor unit)

DC fan motor improves efficiency.

### Switchable fan speed

High setting provides maximum reach while low setting minimises drafts.

### Auto airflow rate

Airflow rate is automatically controlled in accordance with the difference between room temperature and set temperature.

### High fan speed mode

You can increase fan speed approximately 10% higher than the "high" setting.

### Programme "Dry"

Dehumidification is microprocessor controlled to prevent abrupt and uncomfortable changes in air temperature. Useful for reducing uncomfortable humidity without uncomfortable cooling of the room.

### High-ceiling application

Delivers air-conditioning comfort all the way down to the floor in air-conditioning zones with high ceilings.

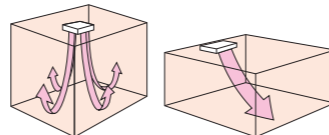

Note: When units are installed on high ceilings, depending on the model, various restrictions concerning maximum height, air discharge direction, and choice of options may apply.

### Two selectable temperature-sensors

Temperature-sensors are included in the indoor unit and optional wired remote controller. Temperature sensing closer to target area is possible to further increase the comfort level.

- Use the temperature-sensor in the indoor unit when controlling air conditioning from another room.

Note: Wireless remote controllers have no temperature-sensor.

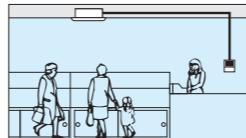

### Hot start

Cold air flow is avoided when heating operation starts or when switching to heat after defrosting.

### Year-round cooling applicable

Efficient cooling even in winter when the indoor temperatures are higher than those outside, such as in underground public spaces or offices with many computers.

### Night quiet operation

The Automatic night quiet mode will initiate 8 hours after the peak temperature is reached in the daytime, and normal operation will resume 10 hours after that.

## Remote Controller

### Setpoint auto reset

Even if the set temperature is changed, after a preset period new set temperature returns to preset value.

### Setpoint range set

Saves energy by limiting the minimum and maximum set temperatures. Avoids excessive heating and cooling.

### Weekly schedule timer

Up to five operation ON/OFF settings can be programmed per day for each day of the week. Not only can the time be set for the operation ON setting, but also the temperature.

### Off timer (programmed)

Sets and saves setting for an increment of time that automatically turns off air conditioner after a preset period of time for each time operation starts.

### On/Off timer

Operation starts when the preset time of the ON timer elapses and stops when the preset time of the OFF timer elapses.

## Cleanliness

### Anti-bacterial air filter

The air filter has an anti-bacterial treatment to help prevent the growth of bacteria and mould on it.

### Mould-proof air filter

Sanitary filter has mould-resistant treatment.

### Silver ion anti-bacterial drain pan

A built-in antibacterial treatment that uses silver ion in the drain pan prevents the growth of slime, bacteria, and mould that cause smells and clogging.

### Mould-proof drain pan

Mould-proof drain pan prevents growth of mould in highly humid conditions.

## Work and Servicing

### Drain pump mechanism

Steeper gradient realises more efficient condensate drainage. High-lift is especially useful for long lengths of drain piping.

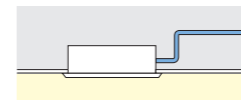

### Pre charged for up to 30 m

If refrigerant piping length does not exceed 30 m, there is no need for on-site gas charging.

\*Applicable to RZR/RZQ series. RKS/RXS series: 10 m

### Long-life filter

Maintenance is not required for one year\*. The filter is washable and can be reused.

\*For dust concentration of 0.15 mg/m<sup>3</sup>

### Filter sign

The filter sign warns you when it is time to clean the filter.

\*When using a wired remote controller the sign is displayed in the LCD. When using a wireless remote controller the filter sign lamp illuminates on the signal receiver unit.

### Ceiling soiling prevention

Daikin's innovative air discharge mechanism keeps airflow away from the ceiling. Ceiling cleaning is less frequently required.

### Low gas pressure detection

Insufficient gas charging is normally hard to detect. During test run after installation and regular inspection, the refrigerant level is monitored by a microprocessor to maintain proper gas pressure. Reliability is assured and maintenance and inspection can be carried out more quickly.

### Emergency operation

Even if there is a malfunction elsewhere in the system, the fan or compressor can still be operated. (depending on the malfunction)

### Self-diagnosis function

The operating parameters of indoor and outdoor units, and sensor data at critical locations throughout the system, are constantly monitored using a microcomputer. To facilitate quick response in the event of a malfunction, a message appears on the LCD of the remote controller and an LED on the unit illuminates.

## Control features

### Auto-restart

If there is a power outage while the equipment is operating, operations will restart in the same mode as before the power cut when electricity is restored.

### Auto-cooling / heating change-over

Detects difference in preset temperature and actual room temperature and automatically switches to cooling or heating accordingly.

### Control by 2 remote controllers

Using 2 remote controllers you can operate the equipment locally or from a remote location.

Note: When a wireless remote controller is used, remote control by two remote controllers is not possible.

### Group control by 1 remote controller

You can turn up to 16 indoor units on/off with a single remote controller. (When using connected indoor units, the settings must all be the same and on/off will be simultaneous.)

### External command control

Operation and monitoring is carried out using the contact signal from the operation control box in the building monitoring room.

\*An option is required.

### Central remote control

Optional central remote controller enables centralised control of up to 1024 indoor units (64 groups) from up to 1 km away.

### Interlock control with Heat Reclaim Ventilator

Enables interlocking control with external equipment such as Heat Reclaim Ventilator.

### DIII-NET communication standard

Standardly equipped interface enables connection to centralised control system without need of an adaptor.

## Options

### High-efficiency filter

Two types are available: 65% and 90% colorimetry.

### Fresh-air intake kit

You can provide air-conditioning with fresh air from outside. Convenient for places where a ventilation fan cannot be installed.

### Ultra long-life filter

Requires no maintenance for about 4 years\* (10,000h) in stores and offices.

\*For dust concentration of 0.15 mg/m<sup>3</sup>

## Others

### Anti corrosion treated heat exchangers

To achieve increased durability by improved resistance to salt corrosion and atmospheric pollution, Anti corrosion treated fin for heat exchangers (with special coating) are used for the heat exchanger of the outdoor unit. In high corrosive areas, regular maintenance needs to be carried out.

# SPECIFICATIONS

## CEILING MOUNTED CASSETTE TYPE Cooling only



Model Name		Indoor unit		50	60	71	100	125	140		
		Outdoor unit		FCQ50KAWEA	FCQ60KAWEA	FCQ71KAWEA	FCQ100KAWEA	FCQ125KAWEA	FCQ140KAWEA		
Power supply		Outdoor unit		1 Phase, 220-240 V, 50 Hz			3 Phase, 380-415 V, 50 Hz				
Cooling capacity <sup>1,2</sup> Rated (Min. - Max.)		kW	5.0 (2.3-5.6)		6.0 (2.6-6.3)		7.1 (3.2-8.0)		10.0 (5.0-11.2)		
			Btu/h	17,100 (7,900-19,100)		20,500 (8,900-21,500)		24,200 (10,900-27,300)		34,100 (17,100-38,200)	
Power consumption		Cooling <sup>1</sup>		1.24		1.58		1.99		2.78	
COP		W/W	4.03		3.80		3.57		2.90		
CSPF		Wh/Wh	6.47		6.19		5.99		5.13		
Indoor unit	Colour	Unit	Fresh white								
	Airflow rate (H/M/L)	m <sup>3</sup> /min	21/17.5/13.5		32/26/20		33/28/22.5				
		cfm	741/618/477		1,130/918/706		1,165/988/794				
	Sound pressure level <sup>3</sup> (H/M/L)	dB(A)	35/31.5/28		43/37.5/32		44/39/34		44/40/36		
	Dimensions (H×W×D)	Unit	256×840×840		50×950×950		298×840×840				
	Machine weight	Unit	21		5.5		24				
		Decoration panel	kg		kg		kg		kg		
Certified Operation range	°CWB	14 to 25		14 to 25		14 to 25		14 to 25			
Outdoor unit	Colour	Ivory white									
	Coil	Type	Cross fin coil			Micro channel					
	Compressor	Type	Hermetically sealed swing type								
		Motor output	kW	1.12		1.35		1.76		1.92	
	Refrigerant charge (R-410A)	kg	1.6 (Charged for 30 m)			1.9 (Charged for 30 m)					
	Sound pressure level <sup>3</sup>	Cooling	dB(A)	48		49		52		54	
		Night quiet mode	dB(A)	44		45		45		45	
	Dimensions (H×W×D)	mm	595×845×300			990×940×320					
	Machine weight	kg	43		73		73				
	Certified Operation range	°CDB	21 to 46		21 to 46		21 to 46		21 to 46		
Piping connections	Liquid (Flare)	mm	φ9.5								
	Gas (Flare)	mm	φ15.9								
	Drain	Indoor unit	VP25 (I.D.φ25×O.D.φ32)			φ26.0 (Hole)			φ26.0 (Hole)		
Max. interunit piping length	m	50 (Equivalent length 70)			50 (Equivalent length 70)			50 (Equivalent length 70)			
Max. installation level difference	m	30									
Heat insulation	Both liquid and gas piping										

Note :  
<sup>1</sup>Rated cooling capacities are based on the following conditions: Indoor temp., 27°CDB, 19.0°CWB; outdoor temp. 35°CDB, 24°CWB. Equiv. refrigeration piping, 7.5 m (horizontal).  
<sup>2</sup>Capacities are net, including a deduction for cooling for indoor fan motor heat.  
<sup>3</sup>The operation sound is measured in anechoic chamber. If it is measured under the actual installation conditions, it is normally over the set value due to environmental noise and sound reflection.



## CEILING SUSPENDED TYPE Cooling only

Model Name		Indoor unit		35						
		Outdoor unit		FHQ35BVV1B						
Power supply		Outdoor unit		1 Phase, 220-240 V, 50 Hz						
Cooling capacity <sup>1,2</sup> Rated (Min. - Max.)		kW	3.4 (1.2-3.7)							
			Btu/h	11,600 (4,100-12,600)						
Power consumption		Cooling <sup>1</sup>		1.05						
COP		W/W	3.24							
CSPF		Wh/Wh	6.47							
Indoor unit	Colour	White								
	Air flow rate (H/L)	m <sup>3</sup> /min	13/10							
		cfm	459/353							
	Sound pressure level (H/L) <sup>2</sup>	dB(A)	37/32							
	Dimensions (H×W×D)	mm	195×960×680							
	Machine weight	kg	24							
	Certified operation range	°CWB	14 to 23							
Outdoor unit	Colour	Ivory white								
	Compressor	Type	Hermetically sealed swing type							
		Motor output	kW	0.6						
	Refrigerant charge (R-410A)	kg	1.0 (Charged for 10 m)							
	Sound pressure level <sup>2</sup>	Cooling	dB(A)	47						
		Night quiet mode	dB(A)	47						
	Dimensions (H×W×D)	mm	550×765×285							
Machine weight	kg	34								
Certified operation range	°CDB	10 to 46								
Piping connections	Liquid (Flare)	mm	φ6.4							
	Gas (Flare)	mm	φ9.5							
	Drain	Indoor unit	VP20 (I.D.φ20×O.D.φ26)			φ18.0 (Hole)				
Max. interunit piping length	m	20								
Max. installation level difference	m	15								
Heat insulation	Both liquid and gas piping									

Note :  
<sup>1</sup>Rated cooling capacities are based on the following conditions: Indoor temp., 27°CDB, 19.0°CWB; outdoor temp. 35°CDB Equiv. refrigeration piping, 7.5 m (horizontal).  
<sup>2</sup>The operation sound is measured in anechoic chamber. If it is measured under the actual installation conditions, it is normally over the set value due to environmental noise and sound reflection.

## COMPACT MULTI FLOW CEILING MOUNTED CASSETTE TYPE Cooling only



Model Name		Indoor unit		25	35	50	60		
		Outdoor unit		FFQ25BV1B	FFQ35BV1B	FFQ50BV1B	FFQ60BV1B		
Power supply		Outdoor unit		1 Phase, 220-240 V, 50 Hz					
Cooling capacity <sup>1,2</sup> Rated (Min. - Max.)		kW	2.5 (1.2-3.0)		3.4 (1.2-3.7)		4.7 (1.7-5.6)		
			Btu/h	8,550 (4,100-10,250)		11,600 (4,100-12,600)		16,000 (5,800-19,100)	
Power consumption		Cooling <sup>1</sup>		0.73		1.10		1.62	
COP		W/W	3.42		3.09		2.90		
CSPF		Wh/Wh	6.18		5.99		5.74		
Indoor unit	Colour	Unit	White						
	Airflow rate (H/M/L)	m <sup>3</sup> /min	9/6.5		10/6.5		12/8		
		cfm	317/229		353/229		423/282		
	Sound pressure level (H/L) <sup>2</sup>	dB(A)	29.5/24.5		32/25		36/27		
	Dimensions (H×W×D)	Unit	286×575×575						
	Machine weight	Unit	55×700×700						
		Decoration panel	mm						
Certified operation range	°CWB	17.5							
Outdoor unit	Colour	Ivory white							
	Compressor	Type	Hermetically sealed swing type						
		Motor output	kW	0.6		1.1		1.1	
	Refrigerant charge (R-410A)	kg	1.0 (Charged for 10 m)			1.5 (Charged for 10 m)			
	Sound pressure level <sup>2</sup>	Cooling	dB(A)	46		47		49	
		Night quiet mode	dB(A)	44		45		45	
	Dimensions (H×W×D)	mm	550×765×285			735×825×300			
	Machine weight	kg	34		47		47		
	Certified operation range	°CDB	10 to 46		10 to 46		10 to 46		
	Piping connections	Liquid (Flare)	mm	φ6.4					
Gas (Flare)		mm	φ9.5						
Drain		Indoor unit	VP20 (I.D.φ20×O.D.φ26)			φ18.0 (Hole)			
Max. interunit piping length	m	20			30				
Max. installation level difference	m	15			20				
Heat insulation	Both liquid and gas piping								

Note :  
<sup>1</sup>Rated cooling capacities are based on the following conditions: Indoor temp., 27°CDB, 19.0°CWB; outdoor temp. 35°CDB Equiv. refrigeration piping, 7.5 m (horizontal).  
<sup>2</sup>The operation sound is measured in anechoic chamber. If it is measured under the actual installation conditions, it is normally over the set value due to environmental noise and sound reflection.



## CEILING SUSPENDED TYPE Cooling only

Model Name		Indoor unit		50	60	71	100	125	140		
		Outdoor unit		FHQ50DAVMA	FHQ60DAVMA	FHQ71DAVMA	FHQ100DAVMA	FHQ125DAVMA	FHQ140DAVMA		
Power supply		Outdoor unit		1 Phase, 220-240 V, 50 Hz			3 Phase, 380-415 V, 50 Hz				
Cooling capacity <sup>1,2</sup> Rated (Min. - Max.)		kW	5.0 (2.3-5.6)		6.0 (2.6-6.3)		7.1 (3.2-8.0)		10.0 (5.0-11.2)		
			Btu/h	17,100 (7,900-19,100)		20,500 (8,900-21,500)		24,200 (10,900-27,300)		34,100 (17,100-38,200)	
Power consumption		Cooling <sup>1</sup>		1.24		1.58		2.37		3.03	
COP		W/W	4.03		3.80		3.00		2.52		
CSPF		Wh/Wh	6.18		5.99		5.74		5.01		
Indoor unit	Colour	white									
	Airflow rate (H/M/L)	m <sup>3</sup> /min	15/12/10		20.5/17/14		28/24/20		31/27/23		
		cfm	530/424/353		724/600/494		988/847/706		1,094/953/812		
	Sound pressure level <sup>3</sup> (H/M/L)	dB(A)	37/35/32		38/36/34		42/38/34		44/41/37		
	Dimensions (H×W×D)	mm	235×960×690			235×1,270×690			235×1,590×690		
	Machine weight	kg	25		32		38				
	Certified operation range	°CWB	14 to 25		14 to 25		14 to 25		14 to 25		
Outdoor unit	Colour	Ivory white									
	Coil	Type	Cross fin coil			Micro channel					
		Type	Hermetically sealed swing type								
	Compressor	Motor output	kW	1.12		1.35		1.76		1.92	
		Refrigerant charge (R-410A)	kg	1.6 (Charged for 30 m)			1.9 (Charged for 30 m)				
	Sound pressure level <sup>2</sup>	Cooling	dB(A)	48		49		52		54	
		Night quiet mode	dB(A)	44		45		45		45	
	Dimensions (H×W×D)	mm	595×845×300			990×940×320					
	Machine weight	kg	43		73		73				
	Certified operation range	°CDB	21 to 46		21 to 46		21 to 46		21 to 46		
Piping connections	Liquid (Flare)	mm	φ9.5								
	Gas (Flare)	mm	φ15.9								
	Drain	Indoor unit	VP20 (I.D.φ20×O.D.φ26)			φ26.0 (Hole)			φ26.0 (Hole)		
Max. interunit piping length	m	50 (Equivalent length 70)			50 (Equivalent length 70)			50 (Equivalent length 70)			
Max. installation level difference	m	30									
Heat insulation	Both liquid and gas piping										

Note :  
<sup>1</sup>Rated cooling capacities are based on the following conditions: Indoor temp., 27°CDB, 19.0°CWB; outdoor temp. 35°CDB, 24°CWB. Equiv. refrigeration piping, 7.5 m (horizontal).  
<sup>2</sup>Capacities are net, including a deduction for cooling for indoor fan motor heat.  
<sup>3</sup>The operation sound is measured in anechoic chamber. If it is measured under the actual installation conditions, it is normally over the set value due to environmental noise and sound reflection.



# SPECIFICATIONS

## WALL MOUNTED TYPE Cooling only



Model Name		Indoor unit		Outdoor unit		
Power supply		Outdoor unit		3 Phase, 380-415 V, 50 Hz		
Cooling capacity <sup>1,2</sup> Rated (Min. - Max.)		kW		10.0 (5.0-11.2)		
		Btu/h		34,100 (17,100-38,200)		
Power consumption		Cooling <sup>1</sup>		kW		
COP		W/W		2.97		
CSPF		Wh/Wh		4.01		
Indoor unit	Colour	Fresh white				
	Airflow rate (H/M/L)	m <sup>3</sup> /min		26/23/19		
		cfm		918/812/671		
	Sound pressure level <sup>3</sup> (H/M/L)	dB(A)		49/45/41		
	Dimensions (H×W×D)	mm		340×1,200×240		
	Machine weight	kg		17		
Certified Operation range		°CWB		14 to 25		
Outdoor unit	Colour	Ivory white				
	Coil	Type	Micro channel			
	Compressor	Type	Hermetically sealed swing type			
		Motor output	kW		1.92	
	Refrigerant charge (R-410A)	kg	1.9 (Charged for 30 m)			
	Sound pressure level <sup>3</sup>	Cooling	dB(A)		49	
		Night quiet mode	dB(A)		45	
	Dimensions (H×W×D)	mm	990×940×320			
	Machine weight	kg	73			
	Certified Operation range	°CDB	21 to 46			
Piping connections	Liquid (Flare)	mm	φ9.5			
	Gas (Flare)	mm	φ15.9			
	Drain	Indoor unit	mm		VP13 (O.Dφ18 × I.Dφ13)	
		Outdoor unit	mm		φ26.0 (Hole)	
Max. interunit piping length		m		50 (Equivalent length 70m)		
Max. installation level difference		m		30		
Heat insulation				Both liquid and gas piping		

Note :  
<sup>1</sup>Rated cooling capacities are based on the following conditions: Indoor temp., 27°CDB, 19.0°CWB; outdoor temp. 35°CDB, 24°CWB. Equiv. refrigeration piping, 7.5 m (horizontal).  
<sup>2</sup>Capacities are net, including a deduction for cooling for indoor fan motor heat.  
<sup>3</sup>The operation sound is measured in anechoic chamber. If it is measured under the actual installation conditions, it is normally over the set value due to environmental noise and sound reflection.

## DUCT CONNECTION MIDDLE STATIC PRESSURE TYPE Cooling only



Model Name		Indoor unit		Outdoor unit		
Power supply		Indoor unit		Outdoor unit		
		1 Phase, 220-240 V, 50 Hz		3 Phase, 380-415 V, 50 Hz		
Cooling capacity <sup>1,2</sup> Rated (Min. - Max.)		kW		5.0 (2.3-5.6)		
		Btu/h		17,100 (7,900-19,100)		
Power consumption		Cooling <sup>1</sup>		kW		
COP		W/W		3.60		
CSPF		Wh/Wh		5.40		
Indoor unit	Colour	White				
	Fan	Airflow rate (H/M/L)	m <sup>3</sup> /min		18/15/12.5	
			cfm		635/530/441	
		External static pressure <sup>3</sup>	Pa		Rated 50 (50-150)	
		Sound pressure level <sup>4</sup> (H/M/L)	dB(A)		35/33/31	
		Air filter <sup>5</sup>				
Outdoor unit	Colour	Ivory white				
	Coil	Type	Cross fin coil		Micro channel	
	Compressor	Type	Hermetically sealed swing type			
		Motor output	kW		1.12	
	Refrigerant charge (R-410A)	kg	1.6 (Charged for 30 m)		1.92 (Charged for 30 m)	
	Sound pressure level <sup>4</sup>	Cooling	dB(A)		48	
		Night quiet mode	dB(A)		44	
	Dimensions (H×W×D)	mm	595×845×300		990×940×320	
	Machine weight	kg	43		73	
	Certified Operation range	°CDB	21 to 46			
Piping connections	Liquid (Flare)	mm	φ9.5			
	Gas (Flare)	mm	φ15.9			
	Drain	Indoor unit	mm		VP25 (I.Dφ25×O.Dφ32)	
		Outdoor unit	mm		φ26.0 (Hole)	
Max. interunit piping length		m		50 (Equivalent length 70)		
Max. installation level difference		m		30		
Heat insulation				Both liquid and gas piping		

Note :  
<sup>1</sup>Rated cooling capacities are based on the following conditions: Indoor temp., 27°CDB, 19.0°CWB; outdoor temp. 35°CDB, 24°CWB. Equiv. refrigeration piping, 7.5 m (horizontal).  
<sup>2</sup>Capacities are net, including a deduction for cooling for indoor fan motor heat.  
<sup>3</sup>External static pressure is changeable in 11 stages by remote controller.  
<sup>4</sup>The operation sound is measured in anechoic chamber. If it is measured under the actual installation conditions, it is normally over the set value due to environmental noise and sound reflection.  
<sup>5</sup>Air filter is not standard accessory, but please mount it in the duct system of the suction side. Select its dust collection efficiency (gravity method) 50% or more.

## CEILING MOUNTED CASSETTE TYPE Heat pump



Model Name		Indoor unit		Outdoor unit		
Power supply		Outdoor unit		3 Phase, 415 V, 50 Hz		
Cooling capacity <sup>1,2</sup> Rated (Min. - Max.)		kW		12.5 (5.7-14.0)		
		Btu/h		42,700 (19,500-47,800)		
Heating capacity <sup>2,3</sup> Rated (Min. - Max.)		kW		14.0 (6.0-16.2)		
		Btu/h		47,800 (20,500-55,300)		
Power consumption		Cooling <sup>1</sup>		kW		
COP		W/W		3.81		
Indoor unit	Colour	Unit		Fresh white		
		Decoration panel				
	Airflow rate (H/M/L)	m <sup>3</sup> /min		21/17.5/13.5		
		cfm		741/618/477		
	Sound pressure level <sup>4</sup> (H/M/L)	dB(A)		35/31.5/28		
	Dimensions (H×W×D)	mm		256×840×840		
	Machine weight	kg		21		
	Certified Operation range	°CWB		14 to 25		
	Outdoor unit	Colour	Ivory white			
		Coil	Type	Cross fin coil		
Compressor		Type	Hermetically sealed scroll type			
		Motor output	kW		1.7	
Refrigerant charge (R-410A)		kg	2.0 (Charged for 30 m)		4.3 (Charged for 30 m)	
Sound pressure level <sup>4</sup>		Cooling / Heating	dB(A)		49/51	
		Night quiet mode	dB(A)		45	
Dimensions (H×W×D)		mm	770×900×320		1,345×900×320	
Machine weight		kg	64		108	
Certified Operation range		Cooling	°CDB		-5 to 46	
	Heating	°CWB		-15 to 15.5		
Piping connections	Liquid (Flare)	mm	φ9.5			
	Gas (Flare)	mm	φ15.9			
	Drain	Indoor unit	mm		VP25 (I.Dφ25×O.Dφ32)	
		Outdoor unit	mm		φ26.0 (Hole)	
Max. interunit piping length		m		50 (Equivalent length 70)		
Max. installation level difference		m		30		
Heat insulation				Both liquid and gas piping		

Note :  
<sup>1</sup>Rated cooling capacities are based on the following conditions: Indoor temp., 27°CDB, 19.0°CWB; outdoor temp. 35°CDB, 24°CWB. Equiv. refrigeration piping, 7.5 m (horizontal).  
<sup>2</sup>Rated heating capacities are based on the following conditions: Indoor temp., 20°CDB, 15°CWB; outdoor temp., 7°CDB, 6°CWB. Equiv. refrigeration piping, 7.5 m (horizontal).  
<sup>3</sup>Capacities are net, including a deduction for cooling for indoor fan motor heat.  
<sup>4</sup>The operation sound is measured in anechoic chamber. If it is measured under the actual installation conditions, it is normally over the set value due to environmental noise and sound reflection.

## COMPACT MULTI FLOW CEILING MOUNTED CASSETTE TYPE Heat pump



Model Name		Indoor unit		Outdoor unit		
Power supply		Indoor unit		Outdoor unit		
		1 Phase, 220-240 V, 50 Hz		3 Phase, 380-415 V, 50 Hz		
Cooling capacity <sup>1</sup> Rated (Min. - Max.)		kW		2.5 (1.2-3.0)		
		Btu/h		8,550 (4,100-10,250)		
Heating capacity <sup>2</sup> Rated (Min. - Max.)		kW		4.0 (1.2-5.0)		
		Btu/h		10,900 (4,100-15,350)		
Power consumption		Cooling <sup>1</sup>		kW		
COP		W/W		3.42		
Indoor unit	Colour	Unit		White		
		Decoration panel				
	Airflow rate (H)	m <sup>3</sup> /min		9/6.5		
		cfm		318/229		
	Sound pressure level <sup>4</sup> (H/L)	dB(A)		29.5/24.5		
	Dimensions (H×W×D)	mm		286×575×575		
	Machine weight	kg		17.5		
	Certified Operation range	°CWB		14 to 23		
	Outdoor unit	Colour	Ivory white			
		Compressor	Type	Hermetically sealed swing type		
		Motor output	kW		0.6	
Refrigerant charge (R-410A)		kg	1.0 (Charged for 10 m)		1.5 (Charged for 10 m)	
Sound pressure level <sup>4</sup>		Cooling/Heating	dB(A)		46/47	
Dimensions (H×W×D)		mm	550×765×285		735×825×300	
Machine weight		kg	34		48	
Certified Operation range		Cooling	°CDB		10 to 46	
		Heating	°CWB		-15 to 20	
Piping connections		Liquid (Flare)	mm	φ6.4		
	Gas (Flare)	mm	φ9.5			
	Drain	Indoor unit	mm		VP20 (I.Dφ20×O.Dφ26)	
		Outdoor unit	mm		φ18.0 (Hole)	
Max. interunit piping length		m		20		
Max. installation level difference		m		15		
Heat insulation				Both liquid and gas piping		

Note :  
<sup>1</sup>Rated cooling capacities are based on the following conditions: Indoor temp., 27°CDB, 19.0°CWB; outdoor temp. 35°CDB, 24°CWB. Equiv. refrigeration piping, 7.5 m (horizontal).  
<sup>2</sup>Rated heating capacities are based on the following conditions: Indoor temp., 20°CDB, 15°CWB; outdoor temp., 7°CDB, 6°CWB. Equiv. refrigeration piping, 7.5 m (horizontal).  
<sup>3</sup>Capacities are net, including a deduction for cooling for indoor fan motor heat.  
<sup>4</sup>The operation sound is measured in anechoic chamber. If it is measured under the actual installation conditions, it is normally over the set value due to environmental noise and sound reflection.

# SPECIFICATIONS

## CEILING SUSPENDED TYPE Heat pump

INVERTER



Model Name	Indoor unit		35	50	60	
	Outdoor unit		FHQ35BVV1B	FHQ50BVV1B	FHQ60BVV1B	
Power supply	Outdoor unit		1 Phase, 220-240 V, 50 Hz			
Cooling capacity <sup>1,3</sup> Rated (Min. - Max.)	kW		3.4 (1.2-3.7)	5.0 (1.7-5.6)	5.7 (1.7-6.0)	
	Btu/h		11,600 (4,100-12,600)	17,100 (5,800-19,100)	19,400 (5,800-20,500)	
Heating capacity <sup>2,3</sup> Rated (Min. - Max.)	kW		4.0 (1.2-5.0)	6.0 (1.7-7.0)	7.2 (1.7-8.0)	
	Btu/h		13,650 (4,100-17,050)	20,500 (5,800-23,700)	24,600 (5,800-27,300)	
Power consumption	Cooling <sup>1</sup>	kW	1.05 (0.3-1.23)	1.72 (0.44-1.98)	2.00 (0.44-2.19)	
	Heating <sup>2</sup>	kW	1.11 (0.29-1.61)	2.04 (0.4-2.40)	2.49 (0.4-2.78)	
COP	Cooling	W/W	3.24 (4.00-3.01)	2.91 (3.86-2.83)	2.85 (3.86-2.74)	
	Heating	W/W	3.60 (4.14-3.11)	2.94 (4.25-2.92)	2.89 (4.25-2.88)	
Indoor unit	Colour		White			
	Fan	Airflow rate (H/L)	13/10			
		m <sup>3</sup> /min	459/353			
		cfm	600/459			
		Sound pressure level <sup>4</sup> (H/L)	37/32	38/33	39/33	
		Dimensions (H×W×D)	195×960×680			
		Machine weight	24	25	27	
		Certified Operation range	Cooling °CWB 14 to 23 Heating °CDB 10 to 30			
	Outdoor unit	Colour		Ivory white		
		Compressor	Type	Hermetically sealed swing type		
		Motor output	0.6	1.1	1.1	
Refrigerant charge (R-410A)		kg	1.0 (Charged for 10 m)	1.5 (Charged for 10 m)	1.5 (Charged for 10 m)	
Sound pressure level <sup>4</sup>		Cooling/Heating	47/48			
		Night quiet mode	49/49			
Dimensions (H×W×D)		mm	550×765×285	735×825×300		
Machine weight		kg	34	48		
Certified Operation range		Cooling	°CDB 10 to 46			
		Heating	°CWB -15 to 20			
Piping connections	Liquid (Flare)	mm	ø6.4			
	Gas (Flare)	mm	ø9.5	ø12.7		
	Drain	Indoor unit Outdoor unit	VP20 (I.D.ø20×O.D.ø26) ø18.0 (Hole)			
Max. interunit piping length	m	20	30			
Max. installation level difference	m	15	20			
Heat insulation	Both liquid and gas piping					

## WALL MOUNTED TYPE Heat pump

Super Inverter



Model Name	Indoor unit		100	
	Outdoor unit		FAQ100CVEA	RZQ100HAY4A
Power supply	Outdoor unit		3 Phase, 415 V, 50 Hz	
Cooling capacity <sup>1,3</sup> Rated (Min. - Max.)	kW		10.0 (5.0-11.2)	
	Btu/h		34,100 (17,100-38,200)	
Heating capacity <sup>2,3</sup> Rated (Min. - Max.)	kW		11.2 (5.1-12.8)	
	Btu/h		38,200 (17,400-43,700)	
Power consumption	Cooling <sup>1</sup>	kW	3.19	
	Heating <sup>2</sup>	kW	3.44	
Indoor unit	Colour		Fresh white	
	Airflow rate (H/M/L)	m <sup>3</sup> /min	26/23/19	
		cfm	918/812/671	
	Sound pressure level <sup>4</sup> (H/M/L)	dB(A)	49/45/41	
	Dimensions (H×W×D)	mm	340×1,200×240	
	Machine weight	kg	17	
	Certified Operation range	Cooling °CWB	14 to 25	
Outdoor unit	Colour		Ivory white	
	Compressor	Type	Hermetically sealed scroll type	
		Motor output	1.7	
	Refrigerant charge (R-410A)	kg	4.3 (Charged for 30 m)	
	Sound pressure level <sup>4</sup>	Cooling/Heating	49/51	
		Night quiet mode	45	
	Dimensions (H×W×D)	mm	1,345×900×320	
Machine weight	kg	108		
Certified Operation range	Cooling	°CDB -5 to 46		
	Heating	°CWB -15 to 15.5		
Piping connections	Liquid (Flare)	mm	ø9.5	
	Gas (Flare)	mm	ø15.9	
	Drain	Indoor unit Outdoor unit	VP13 (I.D.ø13×O.D.ø18) ø26.0 (Hole)	
Max. interunit piping length	m	75 (Equivalent length 90 m)		
Max. installation level difference	m	30		
Heat insulation	Both liquid and gas piping			

## CEILING SUSPENDED TYPE Heat pump

Super Inverter



Model Name	Indoor unit		71	100	125	140	
	Outdoor unit		FHQ71DAVMA	FHQ100DAVMA	FHQ125DAVMA	FHQ140DAVMA	
Power supply	Outdoor unit		1 Phase, 220-240 V, 50 Hz			3 Phase, 415 V, 50 Hz	
Cooling capacity <sup>1,3</sup> Rated (Min. - Max.)	kW		7.1 (3.2-8.0)	10.0 (5.0-11.2)	12.5 (5.7-14.0)	13.2 (6.2-15.5)	
	Btu/h		24,200 (10,900-27,300)	34,100 (17,100-38,200)	42,700 (19,500-47,800)	45,000 (21,200-52,900)	
Heating capacity <sup>2,3</sup> Rated (Min. - Max.)	kW		8.0 (3.5-9.0)	11.2 (5.1-12.8)	14.0 (6.0-16.2)	16.0 (6.2-18.0)	
	Btu/h		27,300 (11,900-30,700)	38,200 (17,400-43,700)	47,800 (20,500-55,300)	54,600 (21,200-61,400)	
Power consumption	Cooling <sup>1</sup>	kW	2.21	3.15	4.01	4.34	
	Heating <sup>2</sup>	kW	2.52	3.54	4.56	4.94	
COP	Cooling	W/W	3.21	3.17	3.12	3.04	
	Heating	W/W	3.17	3.16	3.07	3.24	
Indoor unit	Colour		Light ivory				
	Airflow rate (H/M/L)	m <sup>3</sup> /min	20.5/17/14	28/24/20	31/27/23	34/29/24	
		cfm	724/600/494	988/847/706	1,094/953/812	1,200/1,024/847	
	Sound pressure level <sup>4</sup> (H/M/L)	dB(A)	38/36/34	42/38/34	44/41/37	46/42/38	
	Dimensions (H×W×D)	mm	235×1,270×690	235×1,590×690			
	Machine weight	kg	32	38			
	Certified Operation range	Cooling	°CWB 14 to 25				
		Heating	°CDB 15 to 27				
	Outdoor unit	Colour		Ivory white			
		Coil	Type	Cross fin coil			
Compressor		Type	Hermetically sealed swing type				
		Motor output	1.7	2.3	2.7	2.9	
Refrigerant charge (R-410A)		kg	2.0 (Charged for 30 m)	4.3 (Charged for 30 m)		2.9	
Sound pressure level <sup>4</sup>		Cooling / Heating	48/50				
		Night quiet mode	44				
Dimensions (H×W×D)		mm	770×900×320	45		50/52	
Machine weight		kg	64	108		46	
Certified Operation range		Cooling	°CDB -5 to 46				
	Heating	°CWB -15 to 15.5					
Piping connections	Liquid (Flare)	mm	ø9.5				
	Gas (Flare)	mm	ø15.9				
	Drain	Indoor unit Outdoor unit	VP20 (I.D.ø20×O.D.ø26) ø26.0 (Hole)				
Max. interunit piping length	m	50 (Equivalent length 70)	75 (Equivalent length 90)		30		
Max. installation level difference	m	15				20	
Heat insulation	Both liquid and gas piping						

## CEILING MOUNTED SLIM DUCT TYPE Heat pump

INVERTER



Model Name	Indoor unit		25	35	50	60
	Outdoor unit		FDXS25CVMA	FDXS35CVMA	FDXS50CVMA	FDXS60CVMA
Power supply	Outdoor unit		1 Phase, 220-240 V, 50 Hz			
Cooling capacity <sup>1</sup> Rated (Min. - Max.)	kW		2.4 (1.2-3.0)	3.4 (1.2-3.8)	5.0 (1.7-5.3)	6.0 (1.7-6.5)
	Btu/h		8,150 (4,100-10,200)	11,600 (4,100-12,950)	17,100 (5,800-18,100)	20,500 (5,800-22,200)
Heating capacity <sup>2</sup> Rated (Min. - Max.)	kW		3.2 (1.2-4.5)	4.0 (1.2-5.0)	5.8 (1.7-6.0)	7.0 (1.7-8.0)
	Btu/h		10,900 (4,100-15,350)	13,650 (4,100-17,050)	19,800 (5,800-20,500)	23,900 (5,800-27,300)
Power consumption	Cooling <sup>1</sup>	kW	0.69 (0.3-0.92)	1.09 (0.3-1.27)	1.65 (0.44-1.93)	2.13 (0.44-2.49)
	Heating <sup>2</sup>	kW	0.91 (0.29-1.49)	1.18 (0.29-1.79)	1.92 (0.4-2.04)	2.32 (0.4-3.18)
COP	Cooling	W/W	3.48 (4.00-3.26)	3.12 (4.00-2.99)	3.03 (3.86-2.75)	2.82 (3.86-2.61)
	Heating	W/W	3.52 (4.14-3.02)	3.39 (4.14-2.79)	3.02 (4.25-2.94)	3.02 (4.25-2.52)
Indoor unit	Colour		Ivory white			
	Airflow rate (H/M/L/SL)	m <sup>3</sup> /min	9.5/8.8/8.0/6.7	10.0/9.3/8.5/7.0	12.0/11.0/10.0/8.4	16.0/14.8/13.5/11.2
	Fan	External static pressure	Pa 335/311/282/237			
	Sound pressure level <sup>4</sup> (H/M/L/SL)	dB(A)	40			
	Dimensions (H×W×D)	mm	35/33/31/29		37/35/33/31	38/36/34/32
	Machine weight	kg	25		27	30
	Certified Operation range	Cooling °CWB	14 to 23			
Outdoor unit	Colour		Ivory white			
	Compressor	Type	Hermetically sealed swing type			
		Motor output	0.6			
	Refrigerant charge (R-410A)	kg	1.0 (Charged for 10 m)		1.5 (Charged for 10 m)	
	Sound pressure level <sup>4</sup>	Cooling/Heating (H/L)	46/47		47/48	49/49
		Night quiet mode	45			
	Dimensions (H×W×D)	mm	550×765×285		735×825×300	
Machine weight	kg	34		48		
Certified Operation range	Cooling	°CDB 10 to 46				
	Heating	°CWB -15 to 20				
Piping connections	Liquid (Flare)	mm	ø6.4			
	Gas (Flare)	mm	ø9.5			
	Drain	Indoor unit Outdoor unit	VP20 (I.D.ø20×O.D.ø26) ø18.0 (Hole)			
Max. interunit piping length	m	20				
Max. installation level difference	m	15				
Heat insulation	Both liquid and gas piping					

Note :

<sup>1</sup>Rated cooling capacities are based on the following conditions: Indoor temp., 27°CDB, 19.0°CWB; outdoor temp. 35°CDB, 24°CWB. Equiv. refrigeration piping, 7.5 m (horizontal).

<sup>2</sup>Rated heating capacities are based on the following conditions: Indoor temp., 20°CDB, 15°CWB; outdoor temp., 7°CDB, 6°CWB. Equiv. refrigeration piping, 7.5 m (horizontal).

<sup>3</sup>Capacities are net, including a deduction for cooling for indoor fan motor heat.

<sup>4</sup>The operation sound is measured in anechoic chamber. If it is measured under the actual installation conditions, it is normally over the set value due to environmental noise and sound reflection.

CEILING MOUNTED BUILT-IN TYPE Heat pump

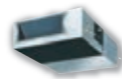

Model Name		Indoor unit		50	60
		Outdoor unit		FBQ50BV1A	FBQ60BV1A
				RXS50FVMA	RXS60FVMA
Power supply		Outdoor unit		1 Phase, 220-240 V, 50 Hz	
Cooling capacity <sup>1</sup>		kW		5.0 (1.7-5.6)	5.7 (1.7-7.0)
Rated (Min. - Max.)		Btu/h		17,100 (5,800-19,100)	19,400 (5,800-23,900)
Heating capacity <sup>2</sup>		kW		6.0 (1.7-7.0)	7.0 (1.7-8.0)
Rated (Min. - Max.)		Btu/h		20,500 (5,800-23,700)	23,900 (5,800-27,300)
Power consumption		Cooling <sup>1</sup>		1.98 (0.44-2.25)	2.23 (0.44-2.83)
		Heating <sup>2</sup>		1.93 (0.4-2.52)	2.26 (0.4-2.94)
COP		Cooling		2.53 (3.86-2.49)	2.56 (3.86-2.47)
		Heating		3.11 (4.25-2.78)	3.10 (4.25-2.72)
Indoor unit	Colour		Ivory white		
	Fan	Air flow rate (H/L)	Cooling	m <sup>3</sup> /min	13/9
			Heating	cmf	459/318
			Cooling	m <sup>3</sup> /min	18/13
			Heating	cmf	636/459
	External static pressure <sup>3</sup> (High-Standard-Low)		Pa		
	Sound pressure level <sup>4</sup> (H/L)		dB(A)		
	Dimensions (HxWxD)		mm		
	Machine weight		kg		
	Certified Operation range		Cooling	°CWB	
		Heating	°CDB		
Outdoor unit	Colour		Ivory white		
	Compressor	Type	Hermetically sealed swing type		
		Motor output	kW		
	Refrigerant charge (R-410A)		kg		
	Sound pressure level <sup>4</sup> (Cooling/Heating)		dB(A)		
	Dimensions (HxWxD)		mm		
	Machine weight		kg		
	Certified Operation range		Cooling	°CDB	
			Heating	°CWB	
	Piping connections	Liquid	mm		
Gas		mm			
Drain		Indoor unit	mm		
		Outdoor unit	mm		
Max. interunit piping length		m			
Max. installation level difference		m			
Heat insulation		Both liquid and gas piping			

Note :  
<sup>1</sup>Rated cooling capacities are based on the following conditions: Suction temp., 27°CDB, 19.0°CWB; outdoor temp. 35°CDB, 24°CWB. Equiv. refrigeration piping, 7.5 m (horizontal)  
<sup>2</sup>Rated heating capacities are based on the following conditions: Suction temp., 20°CDB; outdoor temp., 7°CDB, 6°CWB. Equiv. refrigeration piping, 7.5 m (horizontal)  
<sup>3</sup>Initial setting is standard.  
<sup>4</sup>The operation sound is measured in anechoic chamber. If it is measured under the actual installation conditions, it is normally over the set value due to environmental noise and sound reflection.

DUCT CONNECTION MIDDLE STATIC PRESSURE TYPE Heat pump



Model Name		Indoor unit		71	100	125	140
		Outdoor unit		FBQ71EVE	FBQ100EVE	FBQ125EVE	FBQ140EVE
				RZQ71LV1	RZQ100HAY4A	RZQ125HAY4A	RZQ140HAY4A
Power supply		Outdoor unit		1 Phase, 220-240 V, 50 Hz			
Cooling capacity <sup>1,3</sup>		kW		7.1 (3.2-8.0)	10.0 (5.0-11.2)	12.5 (5.7-14.0)	13.1 (6.2-15.4)
Rated (Min. - Max.)		Btu/h		24,200 (10,900-27,300)	34,100 (17,100-38,200)	42,700 (19,500-47,800)	44,700 (21,200-52,600)
Heating capacity <sup>2,3</sup>		kW		8.0 (3.5-9.0)	11.2 (5.1-12.8)	14.0 (6.0-16.2)	16.0 (6.2-18.0)
Rated (Min. - Max.)		Btu/h		27,300 (11,900-30,700)	38,200 (17,400-43,700)	47,800 (20,500-55,300)	54,600 (21,200-61,400)
Power consumption		Cooling <sup>1</sup>		2.03	3.17	3.97	4.16
		Heating <sup>2</sup>		2.10	3.15	3.95	4.68
COP		Cooling		3.50	3.15	3.15	3.15
		Heating		3.81	3.56	3.54	3.42
Indoor unit	Colour		Ivory white				
	Fan	Airflow rate (H/M/L)	m <sup>3</sup> /min	23/19.5/16	32/27/22.5	36/30.5/25	
			cmf	812/688/565	1,130/953/794	1,271/1,077/883	
	External static pressure <sup>4</sup> (H/M/L)		Pa				
	Sound pressure level <sup>5</sup> (H/M/L)		dB(A)				
	Air filter <sup>6</sup>		mm				
	Dimensions (HxWxD)		mm				
	Machine weight		kg				
	Certified Operation range		Cooling	°CWB			
			Heating	°CDB			
Outdoor unit	Colour		Ivory white				
	Coil	Type	Cross fin coil				
		Compressor	Type	Hermetically sealed scroll type			
	Refrigerant charge (R-410A)		kg				
	Sound pressure level <sup>5</sup> (Cooling / Heating)		dB(A)				
	Night quiet mode		dB(A)				
	Dimensions (HxWxD)		mm				
	Machine weight		kg				
	Certified Operation range		Cooling	°CWB			
			Heating	°CDB			
Piping connections	Liquid (Flare)	mm					
	Gas (Flare)	mm					
	Drain	Indoor unit	mm				
		Outdoor unit	mm				
Max. interunit piping length		m					
Max. installation level difference		m					
Heat insulation		Both liquid and gas piping					

Note :  
<sup>1</sup>Rated cooling capacities are based on the following conditions: Indoor temp., 27°CDB, 19.0°CWB; outdoor temp. 35°CDB, 24°CWB. Equiv. refrigeration piping, 7.5 m (horizontal)  
<sup>2</sup>Rated heating capacities are based on the following conditions: Indoor temp., 20°CDB, 15°CWB; outdoor temp., 7°CDB, 6°CWB. Equiv. refrigeration piping, 7.5 m (horizontal)  
<sup>3</sup>Capacities are net, including a deduction for cooling for indoor fan motor heat.  
<sup>4</sup>External static pressure is changeable in 11 stages by remote controller.  
<sup>5</sup>The operation sound is measured in anechoic chamber. If it is measured under the actual installation conditions, it is normally over the set value due to environmental noise and sound reflection.  
<sup>6</sup>Air filter is not standard accessory, but please mount it in the duct system of the suction side. Select its dust collection efficiency(gravity method) 50% or more.

Indoor unit

CEILING MOUNTED CASSETTE TYPE

Name of option	Remark	Kit name					
		FCQ50KAWEA	FCQ60KAWEA	FCQ71KAWEA	FCQ100KAWEA	FCQ125KAWEA	FCQ140KAWEA
Decoration panel		BYCP125K-W1					
Sealing material of air discharge outlet		KDBH55K160F					
Panel spacer		KDBP55H160FA					
Fresh air intake kit <sup>1</sup>	Chamber type	Without T-duct joint					
	Direct installation type	With T-duct joint					
High-efficiency filter unit (including filter chamber)		KAFP556B80				KAFP556B160	
		KAFP557B80				KAFP557B160	
Replacement high-efficiency filter		KAFP552B80				KAFP552B160	
		KAFP553B80				KAFP553B160	
Filter chamber		KDDF55B160					
Replacement long-life filter		KAFP551K160					
Ultra long-life filter unit (including filter chamber)		KAFP55B160					
Replacement ultra long-life filter		KAFP55H160H					
Branch duct chamber		KDJP55B80			KDJP55B160		
Chamber connection kit <sup>2</sup>		KKSJ55KA160					
Insulation kit for high humidity		KDTP55K80			KDTP55K160		
Remote controller	Wireless type	Cooling only				BRC7F635F	
		Heat pump				BRC7F634F	
	Wired type <sup>3</sup>	BRC2E61					
Navigation Remote Controller	Wired type <sup>3</sup>	BRC1E63					
Central remote controller <sup>4</sup>		DCS302CA61					
Unified ON/OFF controller <sup>4</sup>		DCS301BA61					
Schedule timer <sup>4</sup>		DST301BA61					
intelligent Touch Controller <sup>4</sup>		DCS601C51					
Adaptor for wiring <sup>5</sup>		KRP1C63					
Wiring adaptor for electrical appendices(2) <sup>5</sup>		KRP4AA53					
Installation box for adaptor PCB		KRP1H98					
Remote sensor (for indoor temperature)		BRCS01A-4					

Note: <sup>1</sup>Refer to page 22 for the details.  
<sup>2</sup>Required for installing high-efficiency filter unit and ultra long-life filter unit.  
<sup>3</sup>Wiring for wired remote controller to be procured locally.  
<sup>4</sup>The indoor unit is equipped standardly with the interface adaptor for SkyAir series. An option is unnecessary.  
<sup>5</sup>Installation box for adaptor PCB (KRP1H98) is necessary.

Round flow type: List of optional parts required to achieve different flow patterns

For each flow pattern – all round, 4-way, 3-way, 2-way, branch duct connection – the compatibility of each independently installed option (shown in the column on the left) to accessory options (listed across the top of each table) is shown in the cells where the relevant row and column intersect. A circle (O) indicates compatibility, and a cross (X) indicates incompatibility. Any options not shown below are not suitable for independent or accessory installation.

All round flow 4-way flow

Independently installable optional parts	Optional accessory parts	Panel spacer <sup>1</sup>	Wireless remote controller	Fresh air intake kit (Chamber type) <sup>1,2</sup>	Fresh air intake kit (Direct installation type)	Insulation kit for high humidity	High-efficiency filter unit <sup>2</sup>	Ultra-long-life filter unit <sup>2</sup>
Operation control related	Wireless remote controller	O	O	O	O	O	O	O
Auxiliary function related	Fresh air intake kit (Chamber type) <sup>1,2</sup>	O	O	X	X	O	O	O
	Fresh air intake kit (Direct installation type)	O	O	X	O	O	O	O
	Insulation kit for high humidity	X	O	X	O	X	X	X
Filter related	High-efficiency filter unit <sup>2</sup>	O	O	O	O	X	X	X
	Ultra-long-life filter unit <sup>2</sup>	O	O	O	O	X	X	X

3-way flow 2-way flow

Independently installable optional parts	Optional accessory parts	Panel spacer <sup>1</sup>	Wireless remote controller	Fresh air intake kit (Chamber type) <sup>1,2</sup>	Fresh air intake kit (Direct installation type)	Insulation kit for high humidity	High-efficiency filter unit <sup>2</sup>	Ultra-long-life filter unit <sup>2</sup>
Operation control related	Wireless remote controller	O <sup>3</sup>	O	O	O	O	X	O
Auxiliary function related	Fresh air intake kit (Chamber type) <sup>1,2</sup>	O <sup>3</sup>	O	X	X	X	X	O
	Fresh air intake kit (Direct installation type)	O <sup>3</sup>	O	X	O	X	X	O
Filter related	Insulation kit for high humidity	X	O	X	O	X	X	X
	Ultra-long-life filter unit <sup>2</sup>	O <sup>3</sup>	O	O	O	X	X	X

Branch duct connection

Independently installable optional parts	Optional accessory parts	Panel spacer <sup>1</sup>	Wireless remote controller	Fresh air intake kit (Chamber type) <sup>1,2</sup>	Fresh air intake kit (Direct installation type)	Insulation kit for high humidity	High-efficiency filter unit <sup>2</sup>	Ultra-long-life filter unit <sup>2</sup>
	2-way branch / unit 2-way flow	X	O	O	O <sup>4</sup>	X	X	O
	1-way branch / unit 2-way flow	X	O	O	O <sup>4</sup>	X	X	O

<sup>1</sup>In some cases, depending on how the unit is embedded in the ceiling, use of branch ducts and fresh air intake kits may not be possible. Before starting installation work make sure to check whether or not joint installation is possible. In particular, ensure that the lower fixing position caused by the addition of panel spacers is acceptable.  
<sup>2</sup>Use a chamber connection kit if two different types of optional chamber are used together. In this case, the fresh air intake kit must be installed in the upper position.  
<sup>3</sup>It is not possible to use panel spacers in a 2-way flow installation.  
<sup>4</sup>It is not possible to install a branch duct on the same side to which a fresh air intake kit (direct mount) is installed.

Indoor unit

COMPACT MULTI FLOW CEILING MOUNTED CASSETTE TYPE

Name of option	Remark	Kit name			
		FFQ25BV1B	FFQ35BV1B	FFQ50BV1B	FFQ60BV1B
Decoration panel				BYFQ60B3W1	
Remote controller	Wireless type	Cooling only	BRC7E531W		
			Heat pump	BRC7E530W	
Wired type <sup>1</sup>	BRC2E61				
	Navigation Remote Controller	Wired type <sup>1</sup>	BRC1E63		
Adaptor for wiring <sup>2</sup>		KRP1BA57			
Wiring adaptor for electrical appendices <sup>2</sup>		KRP4AA53			
Remote sensor (for indoor temperature)		BRCS01A-1			
Installation box for adaptor PCB		KRP1BA101			
Central remote controller <sup>3</sup>		DCS302CA61			
Unified ON/OFF controller <sup>3</sup>		DCS301BA61			
Schedule timer <sup>3</sup>		DST301BA61			
intelligent Touch Controller <sup>3</sup>		DCS601C51			
Interface adaptor for SkyAir series		DTA112BA51			
Replacement long-life filter		KAFQ441BA60			
Fresh air intake kit	Direct installation type	KDDQ44XA60			
Sealing material of air discharge outlet		KDBH44BA60			
Panel spacer		KDBQ44BA60A			

Note: <sup>1</sup>Wiring for wired remote controller to be procured locally.  
<sup>2</sup>Installation box for adaptor PCB (KRP1BA101) is necessary.  
<sup>3</sup>This optional accessory requires DTA112BA51.

CEILING SUSPENDED TYPE

Name of option	Remark	Kit name					
		FHQ35BVV1B	FHQ50BVV1B	FHQ60BVV1B	FHQ50DAVMA FHQ60DAVMA	FHQ71DAVMA	FHQ100DAVMA FHQ125DAVMA FHQ140DAVMA
Replacement long-life filter	Resin net	KAF501DA56		KAF501DA80	KAFP501A56	KAFP501A80	KAFP501A160
Fresh air intake kit						KDDQ50A140	
Drain pump kit			KDU50N60VE			KDU50P140VE	
L-type piping kit (for upward direction)		KHFP5MA35		KHFP5MA63		KHFP5N160	
Remote controller	Wireless type	Cooling only	BRC7EA66			BRC7GA56	
			Heat pump	BRC7EA63W			BRC7GA53
Wired type <sup>1</sup>	BRC2E61						
	Navigation Remote Controller	Wired type <sup>1</sup>	BRC1E63				
Central remote controller		DCS302CA61 <sup>2</sup>			DCS302CA61 <sup>3</sup>		
Unified ON/OFF controller		DCS301BA61 <sup>2</sup>			DCS301BA61 <sup>3</sup>		
Schedule timer		DST301BA61 <sup>2</sup>			DST301BA61 <sup>3</sup>		
intelligent Touch Controller		DCS601C51 <sup>2</sup>			DCS601C51 <sup>3</sup>		
Wiring adaptor for electrical appendices		KRP1BA54					
Wiring adaptor for electrical appendices <sup>4</sup>		KRP4AA52					
Interface adaptor for SkyAir series		DTA112BA51					
Installation box for adaptor PCB		KRP1CA93			KRP1D93A		
Adaptor box mounting plate				KKSAP50A56			
Remote sensor (for indoor temperature)		BRCS01A-1			BRCS01A-4		
Electrical box with earth terminal (3 blocks)		KJB311AA					
Electrical box with earth terminal (2 blocks)		KJB212AA					

Note: <sup>1</sup>Wiring for wired remote controller to be procured locally.  
<sup>2</sup>This optional accessory requires DTA112BA51.  
<sup>3</sup>The indoor unit is equipped standardly with the interface adaptor for SkyAir series. An option is unnecessary.  
<sup>4</sup>Installation box for adaptor PCB(KRP1CA93 / KRP1D93A) is necessary.

WALL MOUNTED TYPE

Name of option	Remark	Kit name
		FAQ100CVEA
Drain-up kit		K-KDU572KVE
Remote controller	Wireless type	Cooling only
		Heat pump
Wired type <sup>1</sup>	BRC7EB519	
	BRC7EB518	
Navigation Remote Controller	Wired type <sup>1</sup>	BRC2E61
		BRC1E63
Remote sensor (for Indoor temperature)		BRCS01A-4
Central remote controller <sup>2</sup>		DCS302CA61
Unified ON/OFF controller <sup>2</sup>		DCS301BA61
Schedule timer <sup>2</sup>		DST301BA61
intelligent Touch Controller <sup>2</sup>		DCS601C51
Wiring adaptor for electrical appendices <sup>3</sup>		KRP4AA51
Installation box for adaptor PCB		KRP4AA93
Electrical box with earth terminal (3 blocks)		KJB311AA
Electrical box with earth terminal (2 blocks)		KJB212AA
Noise filter ( For electromagnetic interface use only)		KEK26-1A

Note: <sup>1</sup>Wiring for wired remote controller to be procured locally.  
<sup>2</sup>The indoor unit is equipped standardly with the interface adaptor for SkyAir series. An option is unnecessary.  
<sup>3</sup>Installation box for adaptor PCB (KRP4AA93) is necessary.

Indoor unit

CEILING MOUNTED SLIM DUCT TYPE

Name of option	Remark	Kit name			
		FDXS25CVMA	FDXS35CVMA	FDXS50CVMA	FDXS60CVMA
Wired remote controller <sup>1</sup>		BRC944B2			
Wired remote controller code	Length 3 m (shielded wire)	BRCW901A03			
	Length 8 m (shielded wire)	BRCW901A08			
5-room centralised controller <sup>2</sup>		KRC72A			
Adaptor PCB (normal open/normal open pulse contact) <sup>3</sup>		KRP413AB1S			
The remote controller loss prevention with the chain		KKF917A4			
Interface adaptor for DIII-NET use		KRP928BB2S			
Central remote controller <sup>4</sup>		DCS302CA61			
Unified ON/OFF controller <sup>4</sup>		DCS301BA61			
Schedule timer <sup>4</sup>		DST301BA61			
intelligent Touch Controller <sup>4</sup>		DCS601C51			
Insulation kit for high humidity		KDT25N50			KDT25N63

Note: <sup>1</sup>3 m (BRCW901A03) or 8 m (BRCW901A08) length wired remote controller cord is necessary .  
<sup>2</sup>Adaptor PCB (KRP413AB1S) is also required for each indoor unit.  
<sup>3</sup>Time clock and other devices should be obtained locally.  
<sup>4</sup>This optional accessory requires KRP928BB2S.

CEILING MOUNTED BUILT-IN TYPE

Name of option	Remark	Kit name	
		FBQ50BV1A	FBQ60BV1A
Service panel		KTBJ25K56W	KTBJ25K80W
Air discharge adaptor		KDAJ25K56A	KDAJ25K71A
Remote controller	Wireless type	BRC4C62	
	Heat pump	BRC2E61	
Navigation Remote Controller	Wired type <sup>1</sup>	BRC1E63	
	Wired type <sup>1</sup>	KRP1BA54	
Adaptor for wiring (interlock for fresh air intake fan)		KRP4AA51	
Wiring adaptor for electrical appendices		DTA112BA51	
Interface adaptor for SkyAir series		DCS302CA61	
Central remote controller <sup>2</sup>		DCS301BA61	
Unified ON/OFF controller <sup>2</sup>		DST301BA61	
Schedule timer <sup>2</sup>		DCS601C51	
intelligent Touch Controller <sup>2</sup>		DCS601C51	

Note: <sup>1</sup>Wiring for wired remote controller to be procured locally.  
<sup>2</sup>This optional accessory requires DTA112BA51.

DUCT CONNECTION MIDDLE STATIC PRESSURE TYPE

Name of option	Remark	Kit name						
		FBQ50EVE	FBQ60EVE	FBQ71EVE	FBQ100EVE	FBQ125EVE	FBQ140EVE	
High-efficiency filter <sup>1</sup>	65%	KAFP632B80				KAFP632B160		
	90%	KAFP633B80				KAFP633B160		
Filter chamber(for rear suction) <sup>1</sup>		KDDFP63B80				KDDFP63B160		
Long-life filter <sup>1</sup>		KAFP631B80				KAFP631B160		
Service panel	White	KTBJ25K80W				KTBJ25K160W		
	Fresh white	KTBJ25K80F				KTBJ25K160F		
	Brown	KTBJ25K80T				KTBJ25K160T		
Air discharge adaptor		KDAP25A71A				KDAP25A140A		
Shield plate for side plate		KDBD63A160						
Remote controller	Wireless type	Cooling only	BRC4C66				BRC4C65	
			Heat pump	BRC2E61				BRC1E63
Wired type <sup>2</sup>	KRP1C64*							
	Navigation Remote Controller	Wired type <sup>2</sup>	KRP4AA51*					
Adaptor for wiring		BRCS01A-4						
Wiring adaptor for electrical appendices(2)		KRP4A98						
Remote sensor		DCS302CA61						
Mounting plate for adaptor PCB, <sup>3,4,5</sup>		DCS301BA61						
Central remote controller <sup>6</sup>		DST301BA61						
Unified ON/OFF controller <sup>6</sup>		DST301BA61						
Schedule timer <sup>6</sup>		DCS601C51						
intelligent Touch Controller <sup>6</sup>		DCS601C51						

Note: <sup>1</sup>If installing high efficiency filter and long-life filter to the unit, filter chamber is required.  
<sup>2</sup>Wiring for wired remote controller to be procured locally.  
<sup>3</sup>Mounting plate is necessary for each adaptor marked ★.  
<sup>4</sup>Up to 2 adaptors can be fixed for each mounting plate.  
<sup>5</sup>Only one mounting plate can be installed for each indoor unit.  
<sup>6</sup>The indoor unit is equipped standardly with the interface adaptor for SkyAir series. An option is unnecessary.

Outdoor unit

Name of option	Kit name	
	Cooling only	
	RZR50MVM RZR60MVM RZR71MVM	RZR100MYM RZR125MYM RZR140MYM
Central drain plug	KKP014A4	KKPJ5G280
Fixture for preventing overturning	---	KKTP5B112
Wire fixture for preventing overturning	---	---
Demand adaptor	---	KRP58M51

Name of option	Remark	Kit name			
		Cooling only			
		RKS25EBVMA	RKS35EBVMA	RKS50FVMA	RKS60FVMA
Air direction adjustment grille		KPW937A4		KPW945A4	
Drain plug	One set includes 5 pieces for 5 units	KKP937A4			

Name of option	Kit name			
	Heat pump			
	RZQ71LV1	RZQ100HAY4A	RZQ125HAY4A	RZQ140HAY4A
Central drain plug	KKPJ5F180			
Fixture for preventing overturning	KPT-60B160			
Wire fixture for preventing overturning	K-KYZP15C			
Demand adaptor	KRP58M51			

Name of option	Remark	Kit name			
		Heat pump			
		RXS25EBVMA	RXS35EBVMA	RXS50FVMA	RXS60FVMA
Air direction adjustment grille		KPW937A4		KPW945A4	
Drain plug	One set includes 5 pieces for 5 units	KKP937A4			

Reuse of existing piping: Refrigerant pipe size table

Cooling only

Outdoor Unit	Existing pipe size (Liquid / Gas)	6.4 / 9.5	6.4 / 12.7	6.4 / 15.9	9.5 / 12.7	9.5 / 15.9	9.5 / 19.1	12.7 / 15.9	12.7 / 19.1	12.7 / 22.2	Level difference	Design pressure (High pressure)
		RZR-M series	9.5 / 15.9	Condition	×	■	▲	■	○	△		
		Max.interunit piping length	---	10m	10m	50m	50m	50m	25m	---		
		Pre-charged piping length	---	10m	10m	30m	30m	30m	15m	---		

- Standard pipe size
- Same condition with standard pipe
- △ Piping length and pre-charged piping length are shortened
- ▲ Piping length and pre-charged piping length are much shortened
- Cooling capacity is lowered (pay attention to piping length)
- ×

■ Clean the existing piping if pre-charged piping length is exceed limit of existing piping pump down refrigerant recovery.

CEILING MOUNTED CASSETTE TYPE

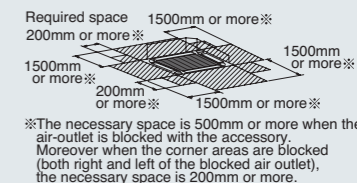
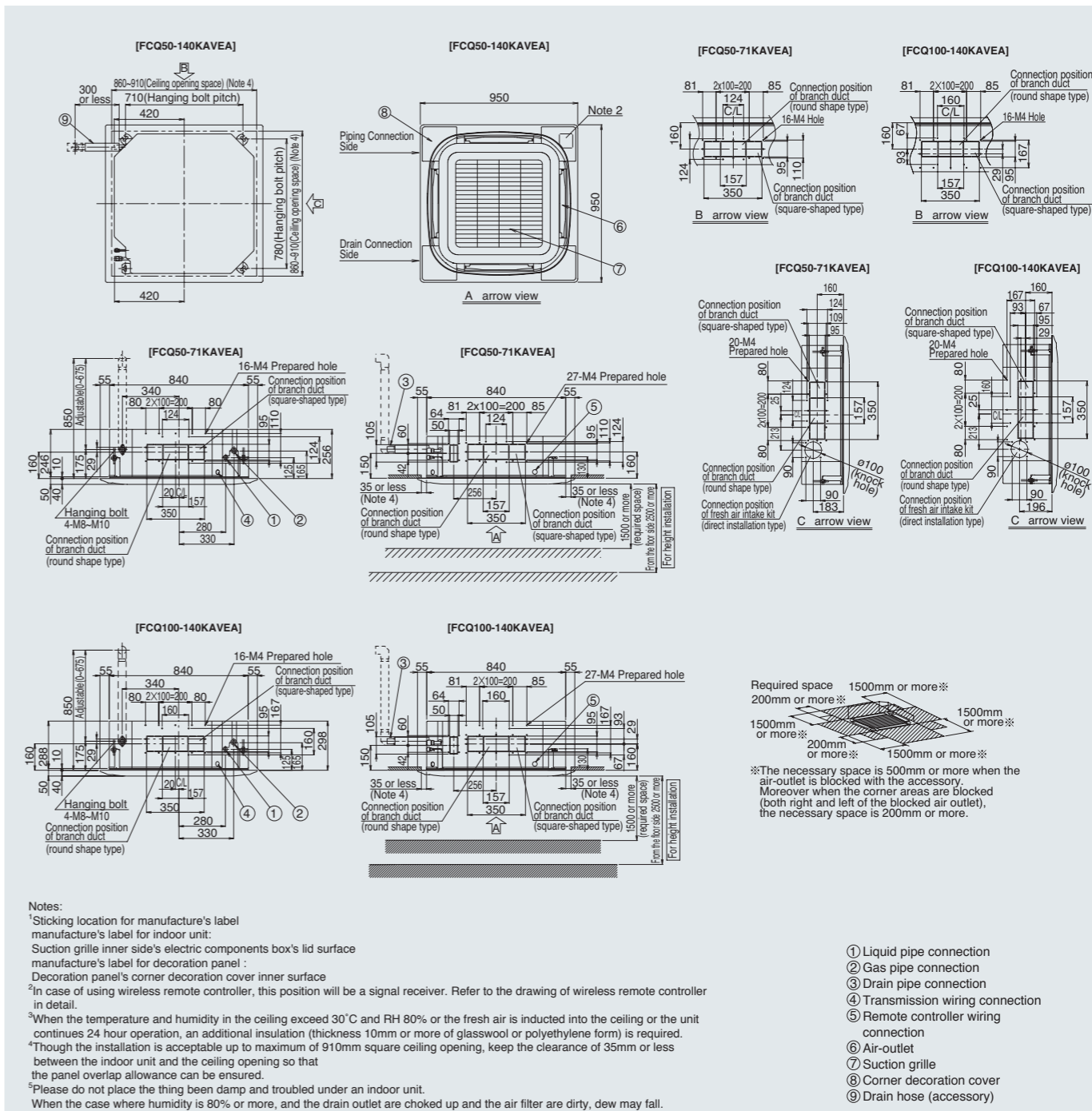

- Notes:
- Sticking location for manufacturer's label  
 manufacturer's label for indoor unit:  
 Suction grille inner side's electric components box's lid surface  
 manufacturer's label for decoration panel :  
 Decoration panel's corner decoration cover inner surface
  - In case of using wireless remote controller, this position will be a signal receiver. Refer to the drawing of wireless remote controller in detail.
  - When the temperature and humidity in the ceiling exceed 30°C and RH 80% or the fresh air is inducted into the ceiling or the unit continues 24 hour operation, an additional insulation (thickness 10mm or more of glasswool or polyethylene form) is required.
  - Though the installation is acceptable up to maximum of 910mm square ceiling opening, keep the clearance of 35mm or less between the indoor unit and the ceiling opening so that the panel overlap allowance can be ensured.
  - Please do not place the thing been damp and troubled under an indoor unit.  
 When the case where humidity is 80% or more, and the drain outlet are choked up and the air filter are dirty, dew may fall.

- ① Liquid pipe connection
- ② Gas pipe connection
- ③ Drain pipe connection
- ④ Transmission wiring connection
- ⑤ Remote controller wiring connection
- ⑥ Air-outlet
- ⑦ Suction grille
- ⑧ Corner decoration cover
- ⑨ Drain hose (accessory)

**COMPACT MULTI FLOW CEILING MOUNTED CASSETTE TYPE**

**[FFQ25-60BV1B]**

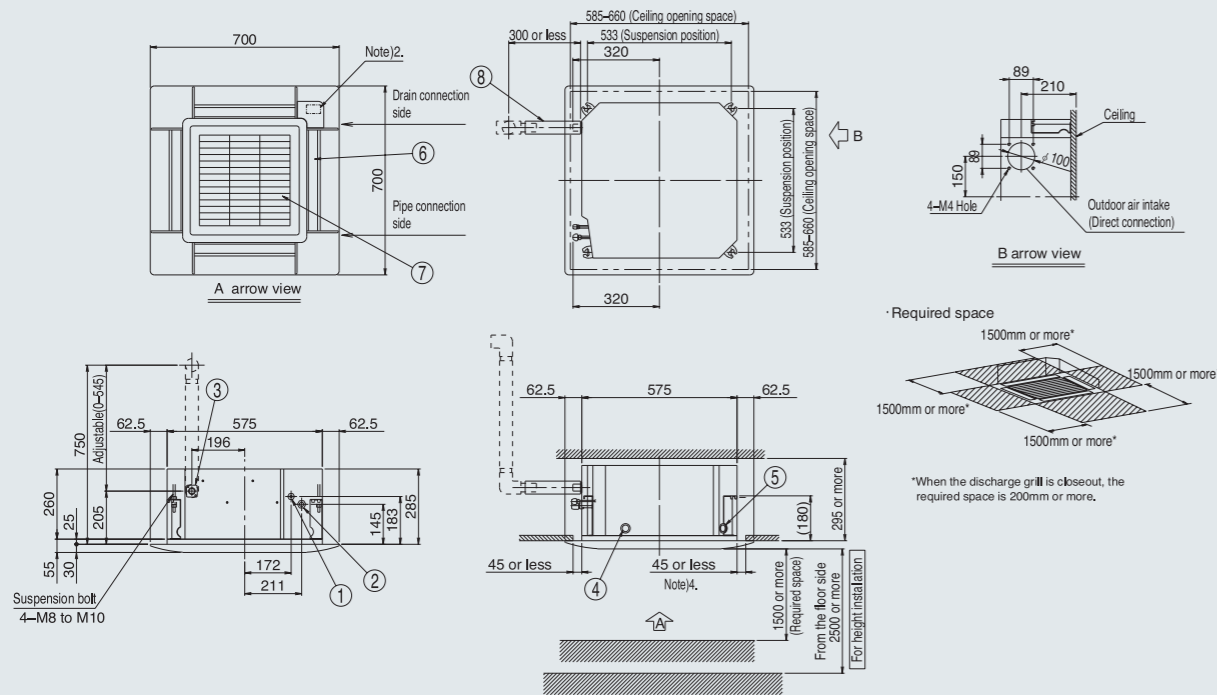

**Notes:**  
 1 Sticking location for manufacture's label  
 2 Location of unit's Name Plate: Bottom of fan housing inside the suction grille.  
 3 In case of using wireless remote controller, this position will be a signal receiver. Refer to the drawing of wireless remote controller in detail.  
 4 When the temperature and humidity in the ceiling exceed 30°C and RH 80% or the fresh air is inducted into the ceiling or the unit continues 24 hour operation, an additional insulation (thickness 10mm or more of glasswool or polyethylene foam) is required.  
 5 Though the installation is acceptable up to maximum of 660mm square ceiling opening, keep the clearance of 45mm or less between the main unit and the ceiling opening so that the panel overlap allowance can be ensured.

- ① Liquid pipe connection
- ② Gas pipe connection
- ③ Drain pipe connection
- ④ Power supply connection
- ⑤ Remote control code and control wiring connection
- ⑥ Air discharge grille
- ⑦ Suction grille
- ⑧ Drain hose

**CEILING SUSPENDED TYPE**

**[FHQ50/60DAVMA]**

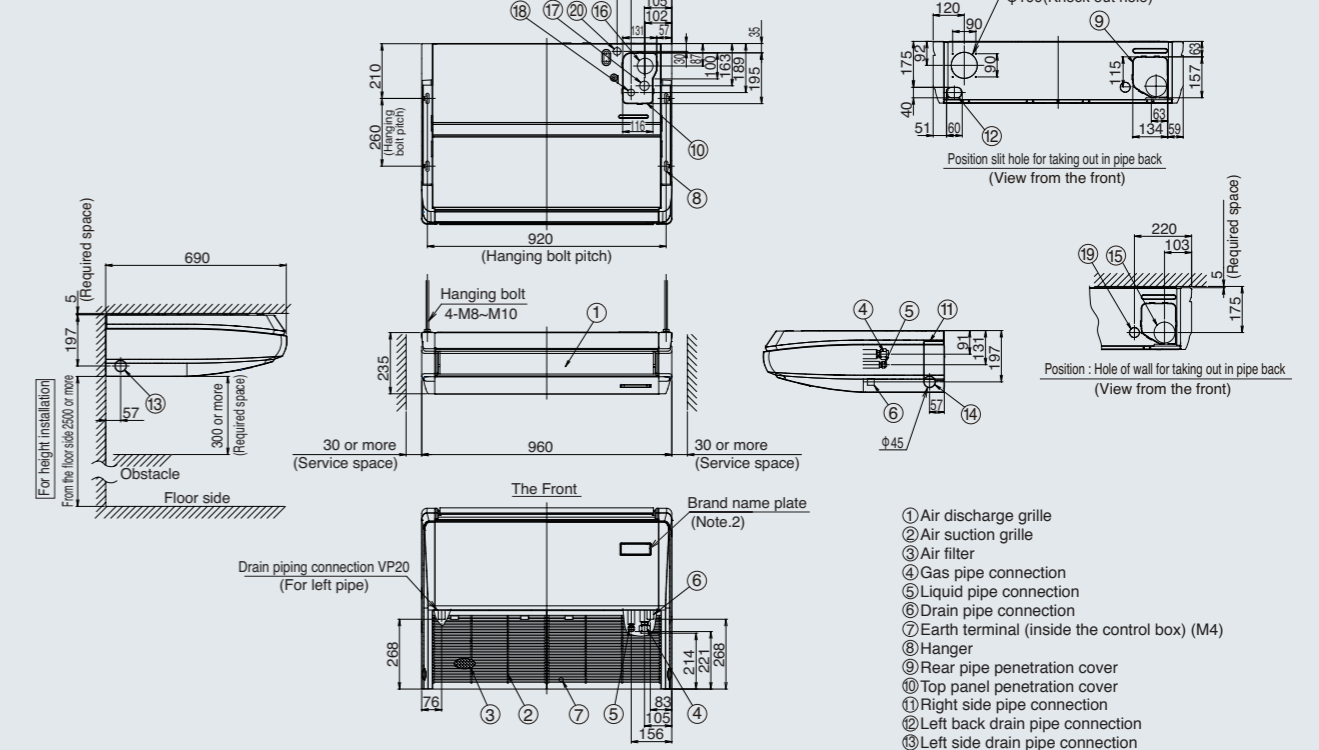

**Notes:**  
 1 Location of unit's Name Plate: Bottom of fan housing inside the suction grille.  
 2 In case of using wireless remote controller, this position will be a signal receiver. Refer to the drawing of wireless remote controller in detail.  
 3 Please do not place the thing been damp and troubled under an indoor unit. When the case where humidity is 80% or more, and the drain outlet are choked up and the air filter are dirty, dew may fall.

- ① Air discharge grille
- ② Air suction grille
- ③ Air filter
- ④ Gas pipe connection
- ⑤ Liquid pipe connection
- ⑥ Drain pipe connection
- ⑦ Earth terminal (inside the control box) (M4)
- ⑧ Hanger
- ⑨ Rear pipe penetration cover
- ⑩ Top panel penetration cover
- ⑪ Right side pipe connection
- ⑫ Left back drain pipe connection
- ⑬ Left side drain pipe connection
- ⑭ Right side drain pipe connection
- ⑮ Hole of wall for taking out in pipe back
- ⑯ Upward drain pipe connection
- ⑰ Upward gas pipe connection
- ⑱ Upward liquid pipe connection
- ⑳ Power supply wiring and a unit wiring back connection
- ㉑ Power supply wiring and a unit wiring upper connection

**CEILING SUSPENDED TYPE**

**[FHQ35/50/60BVV1B]**

	A	B
FHQ35BVV1B	920	960
FHQ50BVV1B	920	960
FHQ60BVV1B	1120	1160

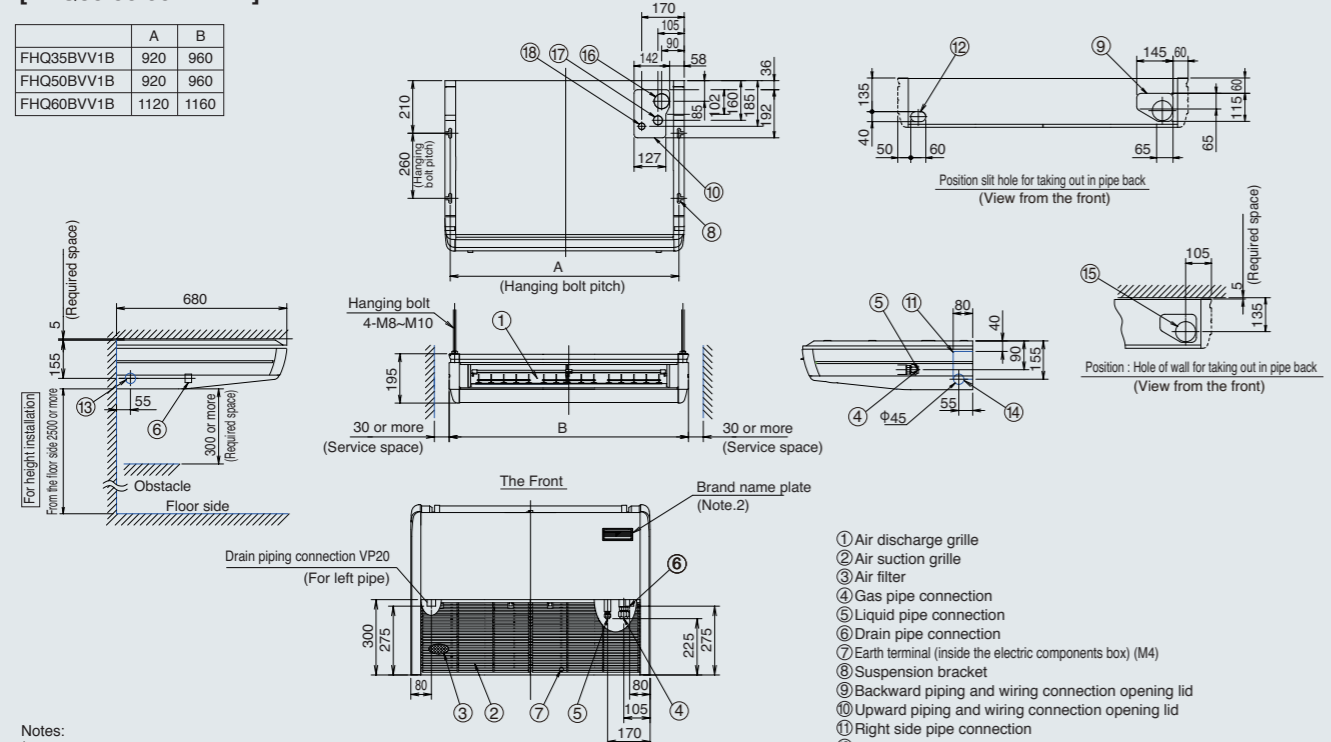

**Notes:**  
 1 Location of unit's Name Plate: Bottom of fan housing inside the suction grille.  
 2 In case of using wireless remote controller, this position will be a signal receiver. Refer to the drawing of wireless remote controller in detail.  
 3 The remote control code is the standard <about 3 m outside the machine> attached. (0.5 mm<sup>2</sup> × 2 wicks × O.D. φ 5.4) (It is not attached to VRV.)

- ① Air discharge grille
- ② Air suction grille
- ③ Air filter
- ④ Gas pipe connection
- ⑤ Liquid pipe connection
- ⑥ Drain pipe connection
- ⑦ Earth terminal (inside the electric components box) (M4)
- ⑧ Suspension bracket
- ⑨ Backward piping and wiring connection opening lid
- ⑩ Upward piping and wiring connection opening lid
- ⑪ Right side pipe connection
- ⑫ Left back drain pipe connection
- ⑬ Left side drain pipe connection
- ⑭ Right side drain pipe connection
- ⑮ Hole of wall for taking out in piping back
- ⑯ Upward drain pipe connection
- ⑰ Upward gas pipe connection
- ⑱ Upward liquid pipe connection

**CEILING SUSPENDED TYPE**

**[FHQ71DAVMA]**

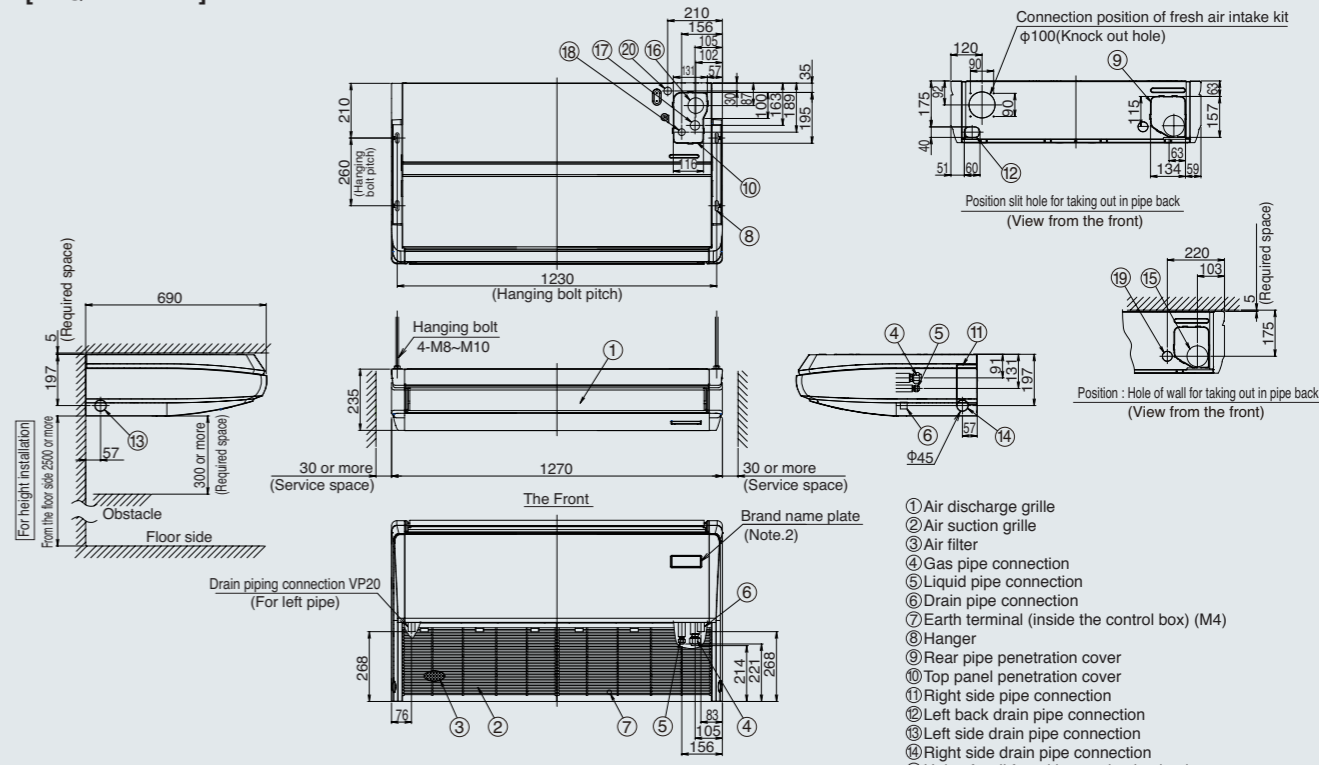

**Notes:**  
 1 Location of unit's Name Plate: Bottom of fan housing inside the suction grille.  
 2 In case of using wireless remote controller, this position will be a signal receiver. Refer to the drawing of wireless remote controller in detail.  
 3 Please do not place the thing been damp and troubled under an indoor unit. When the case where humidity is 80% or more, and the drain outlet are choked up and the air filter are dirty, dew may fall.

- ① Air discharge grille
- ② Air suction grille
- ③ Air filter
- ④ Gas pipe connection
- ⑤ Liquid pipe connection
- ⑥ Drain pipe connection
- ⑦ Earth terminal (inside the control box) (M4)
- ⑧ Hanger
- ⑨ Rear pipe penetration cover
- ⑩ Top panel penetration cover
- ⑪ Right side pipe connection
- ⑫ Left back drain pipe connection
- ⑬ Left side drain pipe connection
- ⑭ Right side drain pipe connection
- ⑮ Hole of wall for taking out in pipe back
- ⑯ Upward drain pipe connection
- ⑰ Upward gas pipe connection
- ⑱ Upward liquid pipe connection
- ⑳ Power supply wiring and a unit wiring back connection
- ㉑ Power supply wiring and a unit wiring upper connection



DUCT CONNECTION MIDDLE STATIC PRESSURE TYPE

[FBQ50-71EVE]

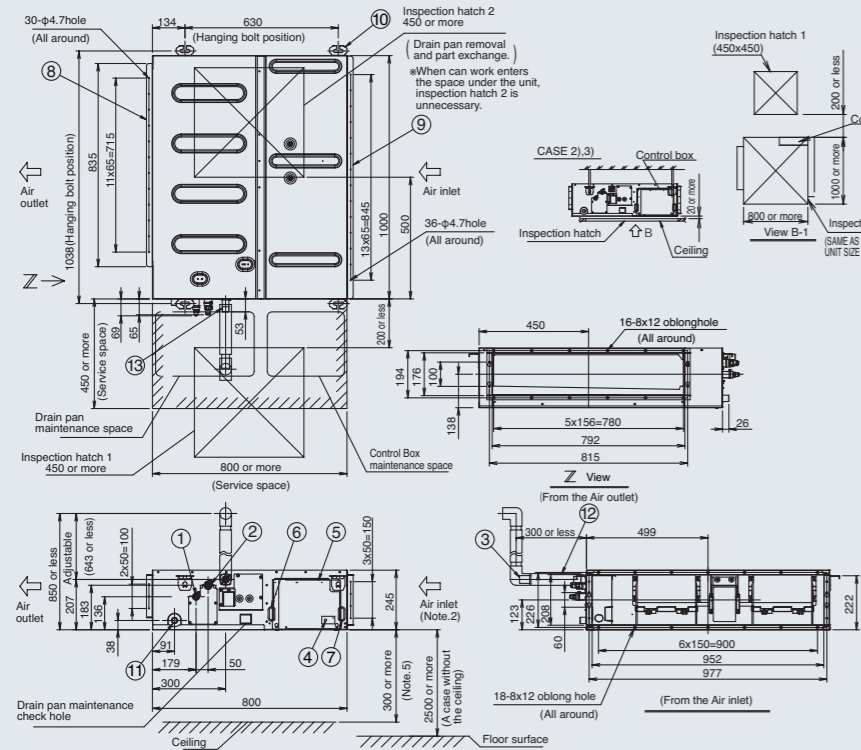

Notes:  
 1) Locations of Manufacturer's Label: Surface of a control box  
 2) Make sure to mount the air filter inside the air passage on the suction side. (Select Duct Collection Efficiency <Gravimetric Method>50% or more.)  
 3) If the temperature and humidity in the ceiling is likely to exceed 30°C and RH80%, strengthen heat insulation by applying the additional insulation materials such as glass wool or polyethylene that has thickness of 10mm or more.  
 4) Do not put things that should not get wet under the indoor unit. Dews may drop when humidity reaches over 80%, a drain gets stuck or air filters are not clean.  
 5) Space for Service Works

Provide service spaces for service work such as check and maintenance of the control box and drain pump by one of the following ways.

- 1) Inspection hatch 1 and 2(450x450) (Fig. A-1) and a space of 300mm or more under the unit. (Fig. A)  
 Note: Inspection hatch 2 is not needed when there is a space for service work under the unit.
- 2) Inspection hatch 1(450x450) on the control box side, and Inspection hatch 2 under the unit. (View B-1)
- 3) Inspection hatch 3 under the unit and control box. (View B-2)

- Provide enough space for maintenance and mount the drain pan and control box.
- Check the drawing of optional accessories when mounting optional accessories such as filter chamber and humidifier.

- ① Liquid pipe connection
- ② Gas pipe connection
- ③ Drain pipe connection
- ④ Earth terminal (terminal in Control box)
- ⑤ Control box (Inside)
- ⑥ Remote control wiring connection
- ⑦ Power supply wiring connection
- ⑧ Air discharge flange
- ⑨ Air suction flange
- ⑩ Hanger
- ⑪ Socket (For maintenance)
- ⑫ Drain hose (Accessory)
- ⑬ Drain hose connection (Accessory)

OUTDOOR UNIT // RKS25/35EBVMA, RXS25/35EBVMA

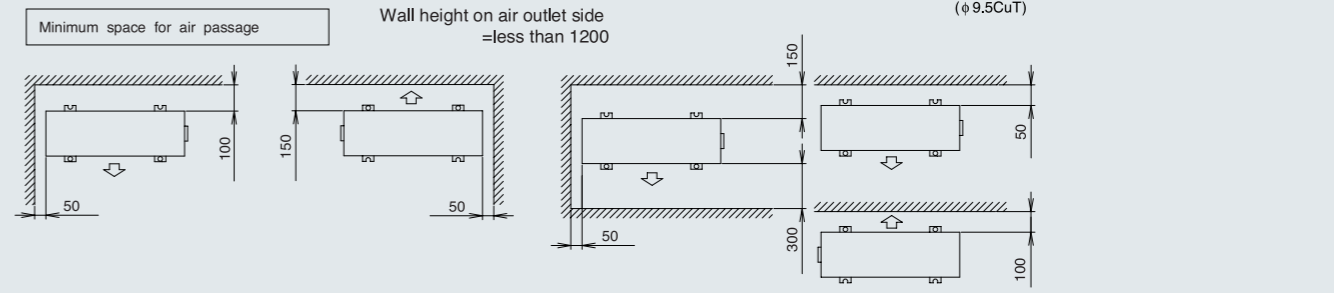
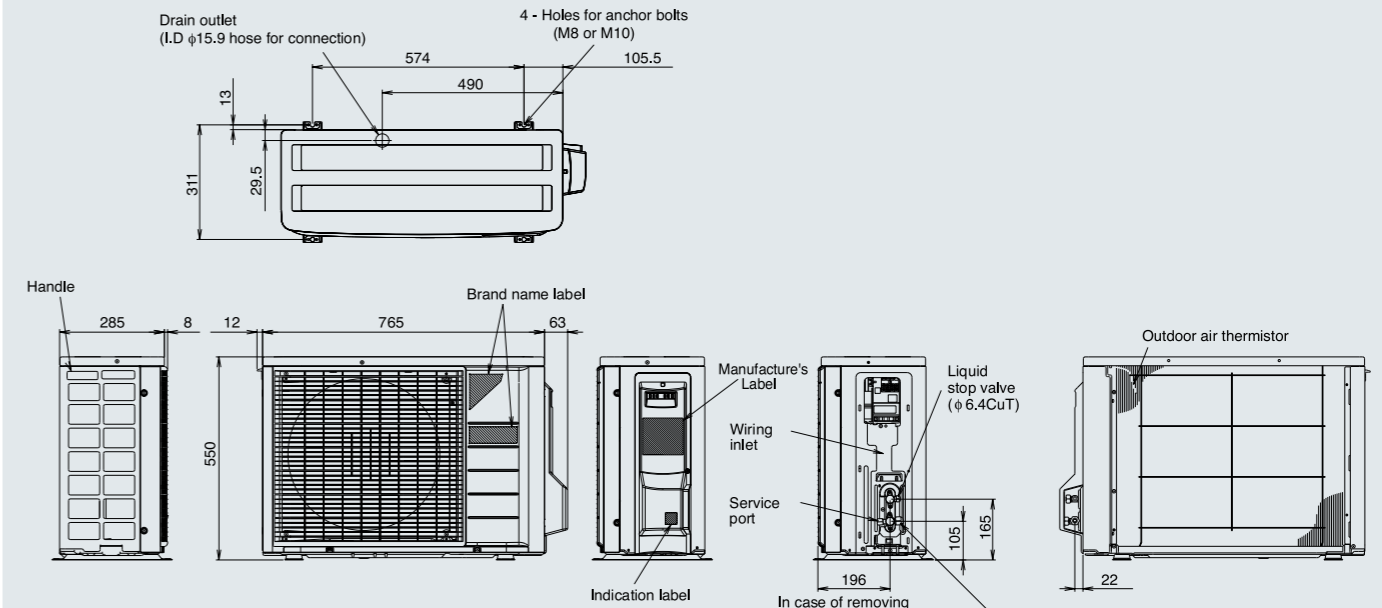

DUCT CONNECTION MIDDLE STATIC PRESSURE TYPE

[FBQ100-140EVE]

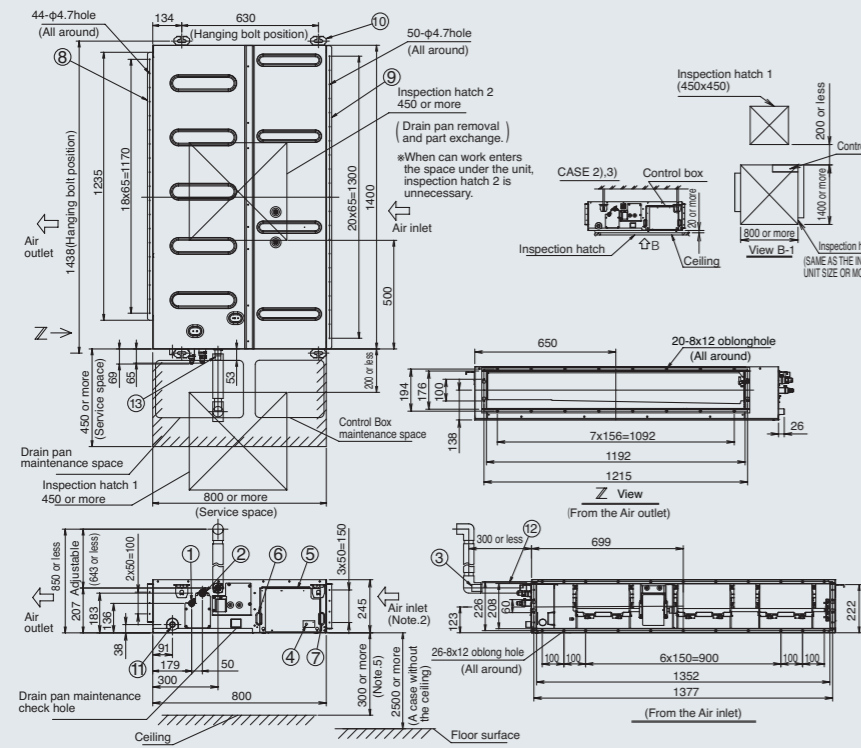

Notes:  
 1) Locations of Manufacturer's Label: Surface of a control box  
 2) Make sure to mount the air filter inside the air passage on the suction side. (Select Duct Collection Efficiency <Gravimetric Method>50% or more.)  
 3) If the temperature and humidity in the ceiling is likely to exceed 30°C and RH80%, strengthen heat insulation by applying the additional insulation materials such as glass wool or polyethylene that has thickness of 10mm or more.  
 4) Do not put things that should not get wet under the indoor unit. Dews may drop when humidity reaches over 80%, a drain gets stuck or air filters are not clean.  
 5) Space for Service Works

Provide service spaces for service work such as check and maintenance of the control box and drain pump by one of the following ways.

- 1) Inspection hatch 1 and 2(450x450) (Fig. A-1) and a space of 300mm or more under the unit. (Fig. A)  
 Note: Inspection hatch 2 is not needed when there is a space for service work under the unit.
- 2) Inspection hatch 1(450x450) on the control box side, and Inspection hatch 2 under the unit. (View B-1)
- 3) Inspection hatch 3 under the unit and control box. (View B-2)

- Provide enough space for maintenance and mount the drain pan and control box.
- Check the drawing of optional accessories when mounting optional accessories such as filter chamber and humidifier.

- ① Liquid pipe connection
- ② Gas pipe connection
- ③ Drain pipe connection
- ④ Earth terminal (terminal in Control box)
- ⑤ Control box (Inside)
- ⑥ Remote control wiring connection
- ⑦ Power supply wiring connection
- ⑧ Air discharge flange
- ⑨ Air suction flange
- ⑩ Hanger
- ⑪ Socket (For maintenance)
- ⑫ Drain hose (Accessory)
- ⑬ Drain hose connection (Accessory)

OUTDOOR UNIT // RKS50/60FVMA, RXS50/60FVMA

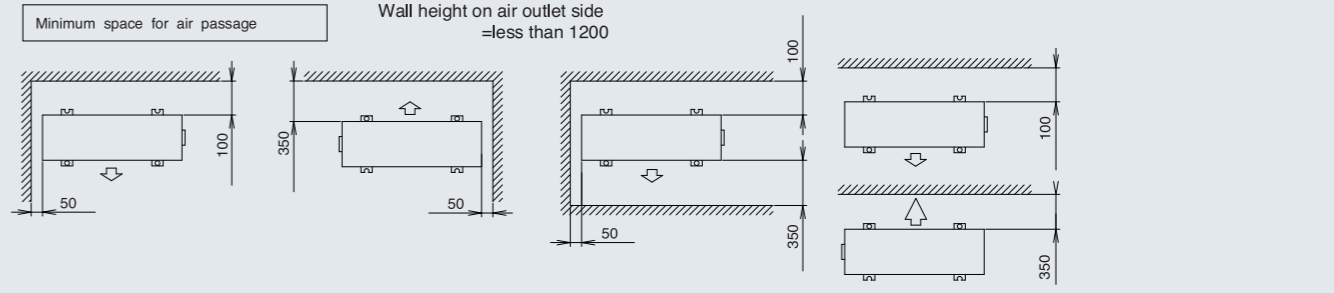
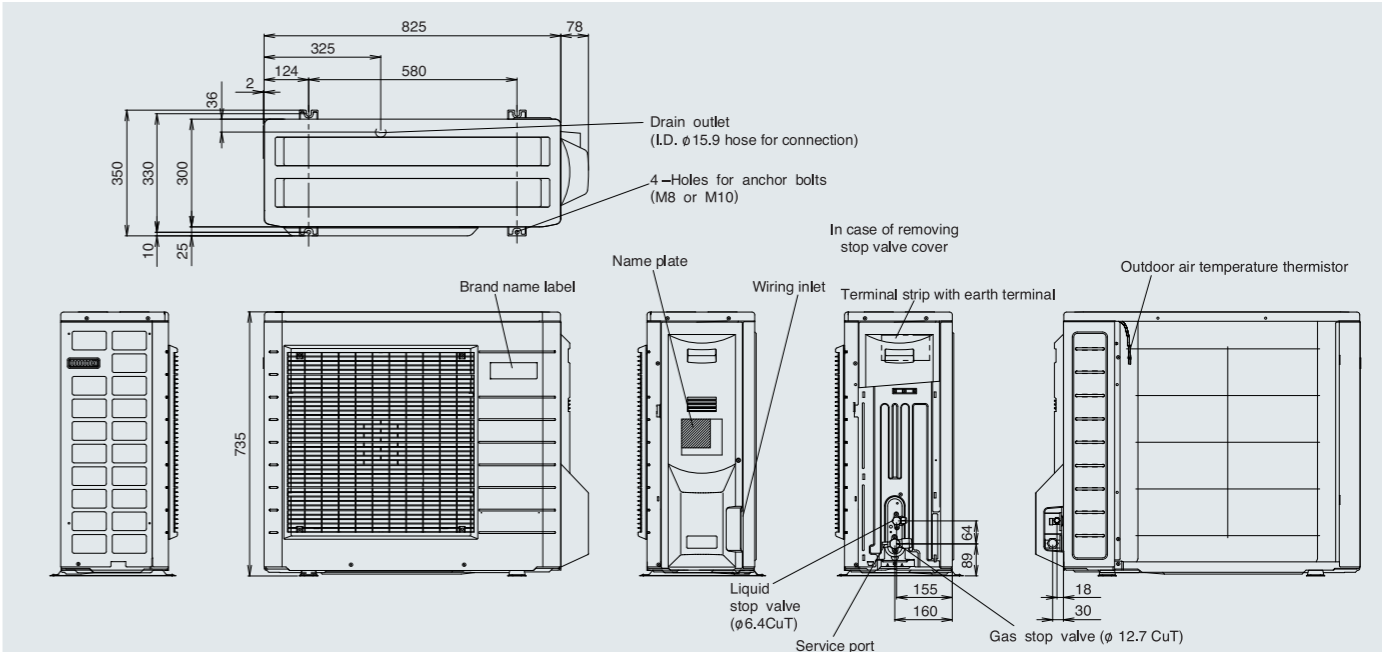



**OUTDOOR UNIT // RZR50/60/71MVM**

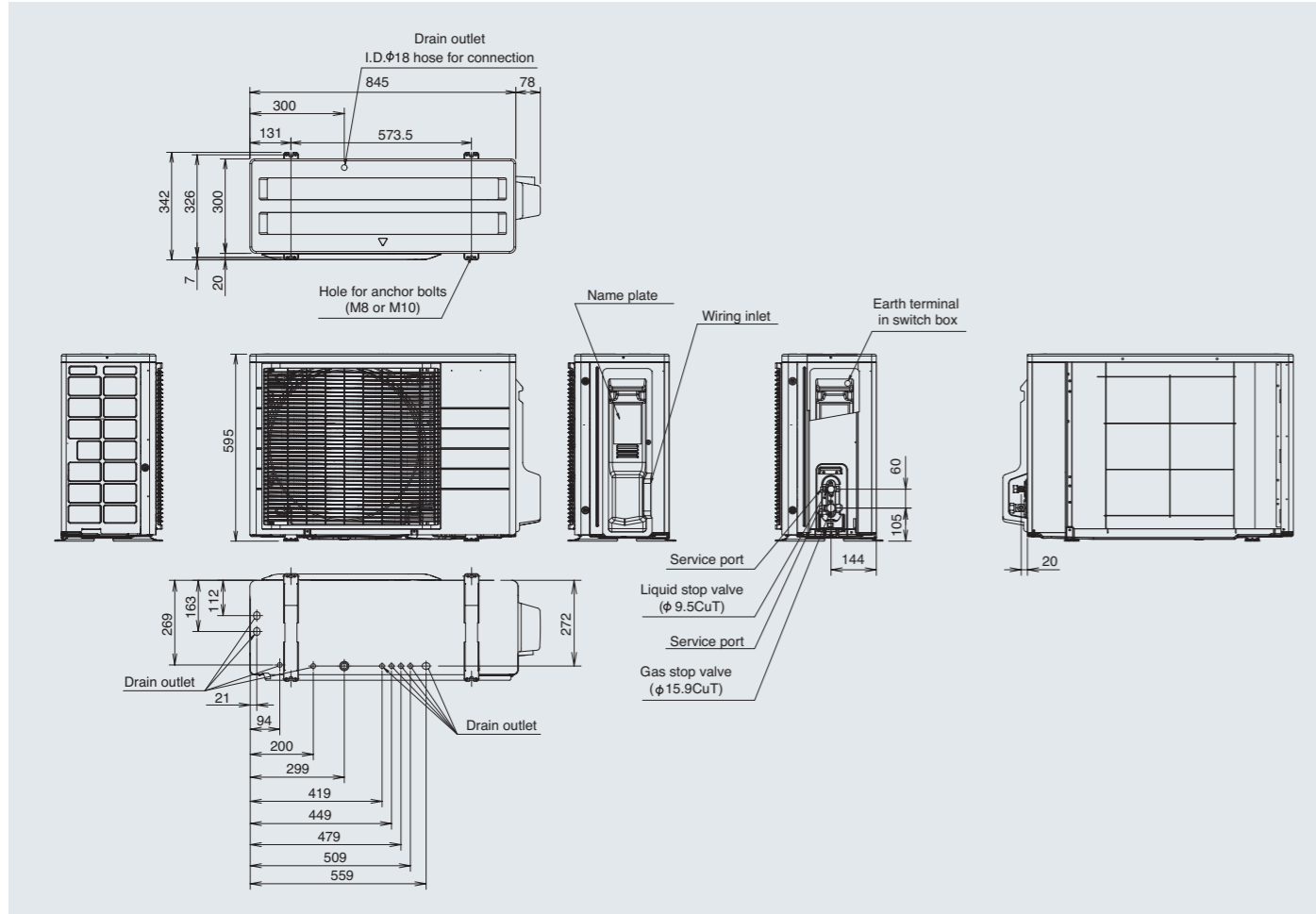

**OUTDOOR UNIT // RZQ71LV1**

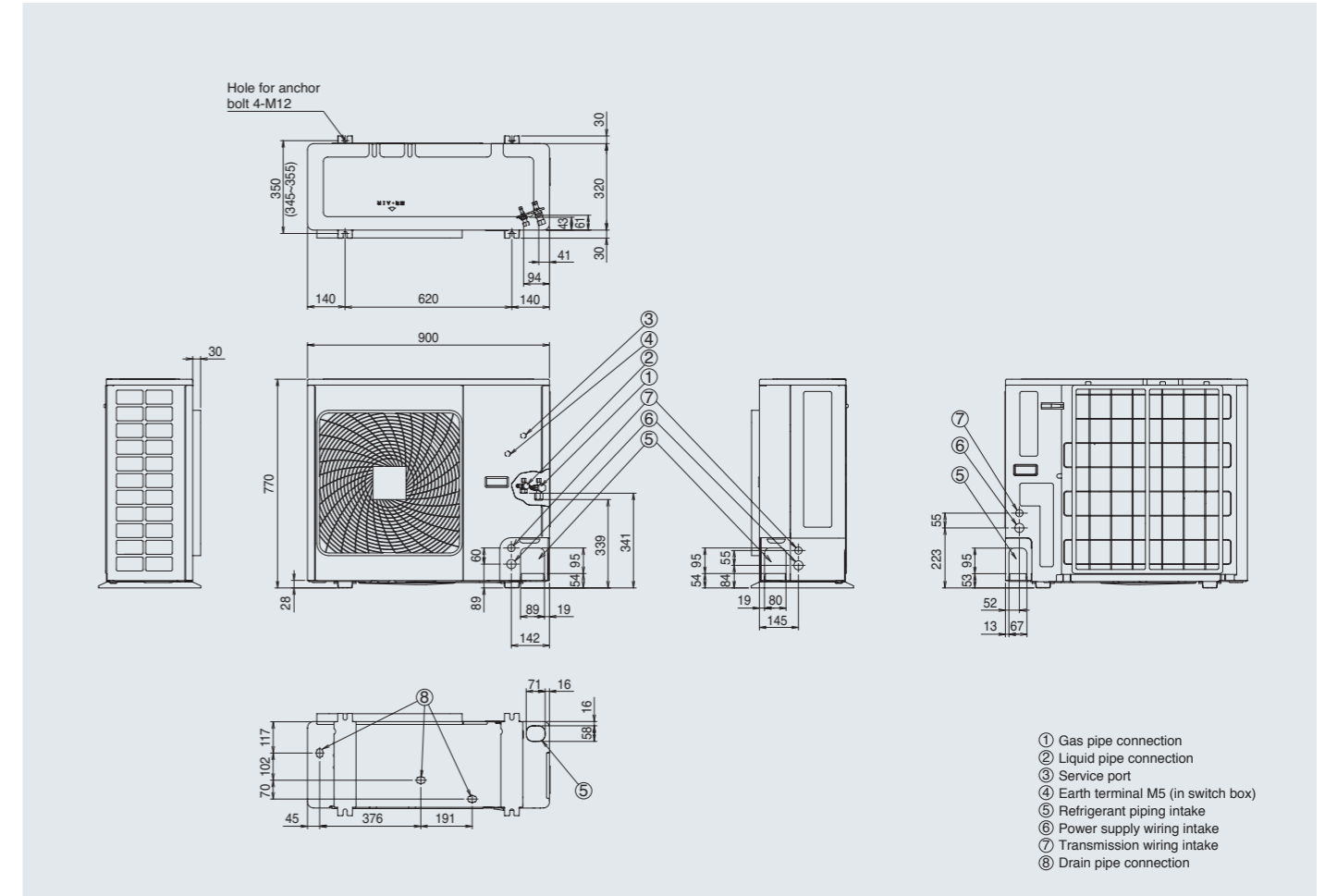

**OUTDOOR UNIT // RZR100/125/140MYM**

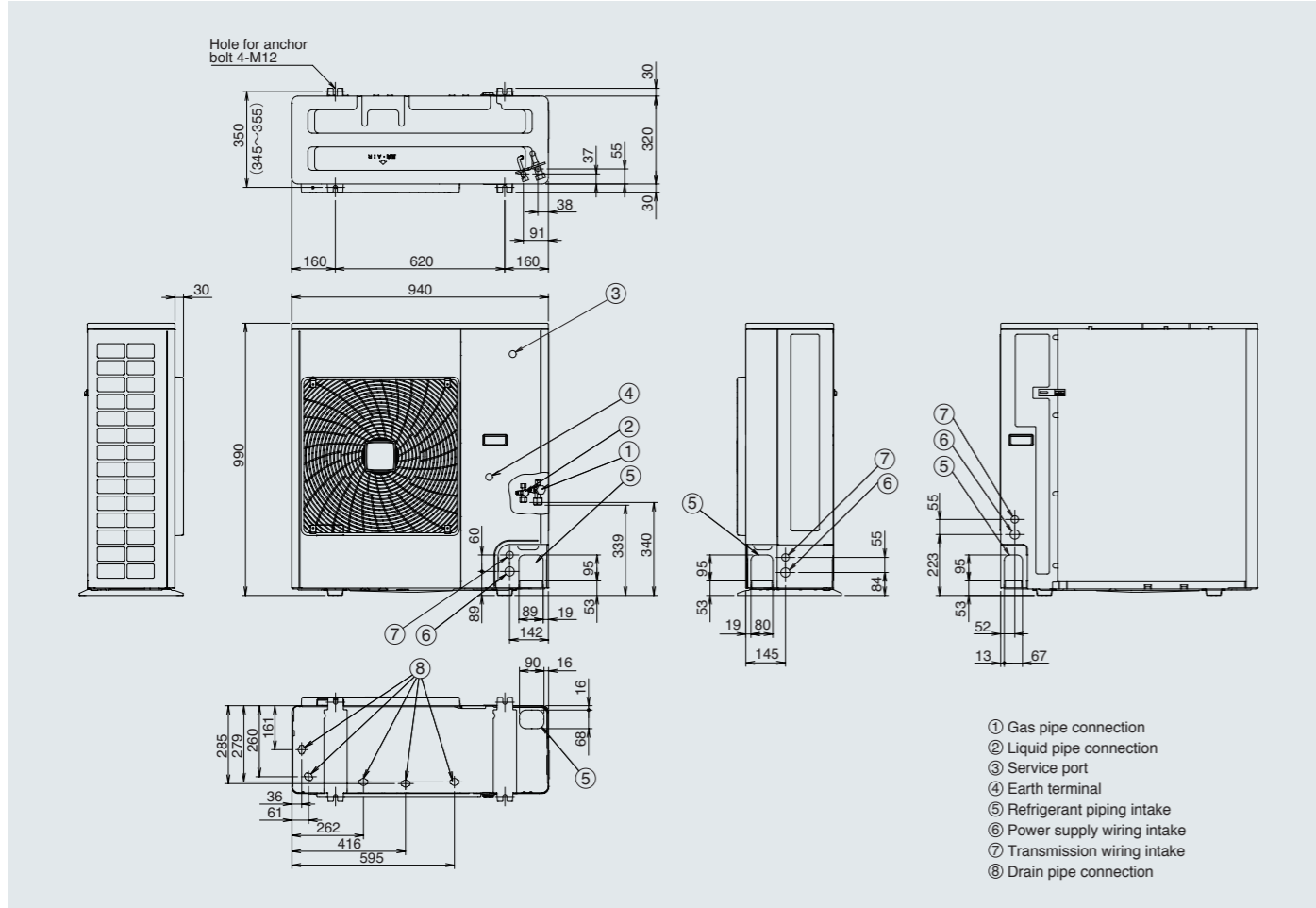

**OUTDOOR UNIT // RZQ100/125/140HAY4A**

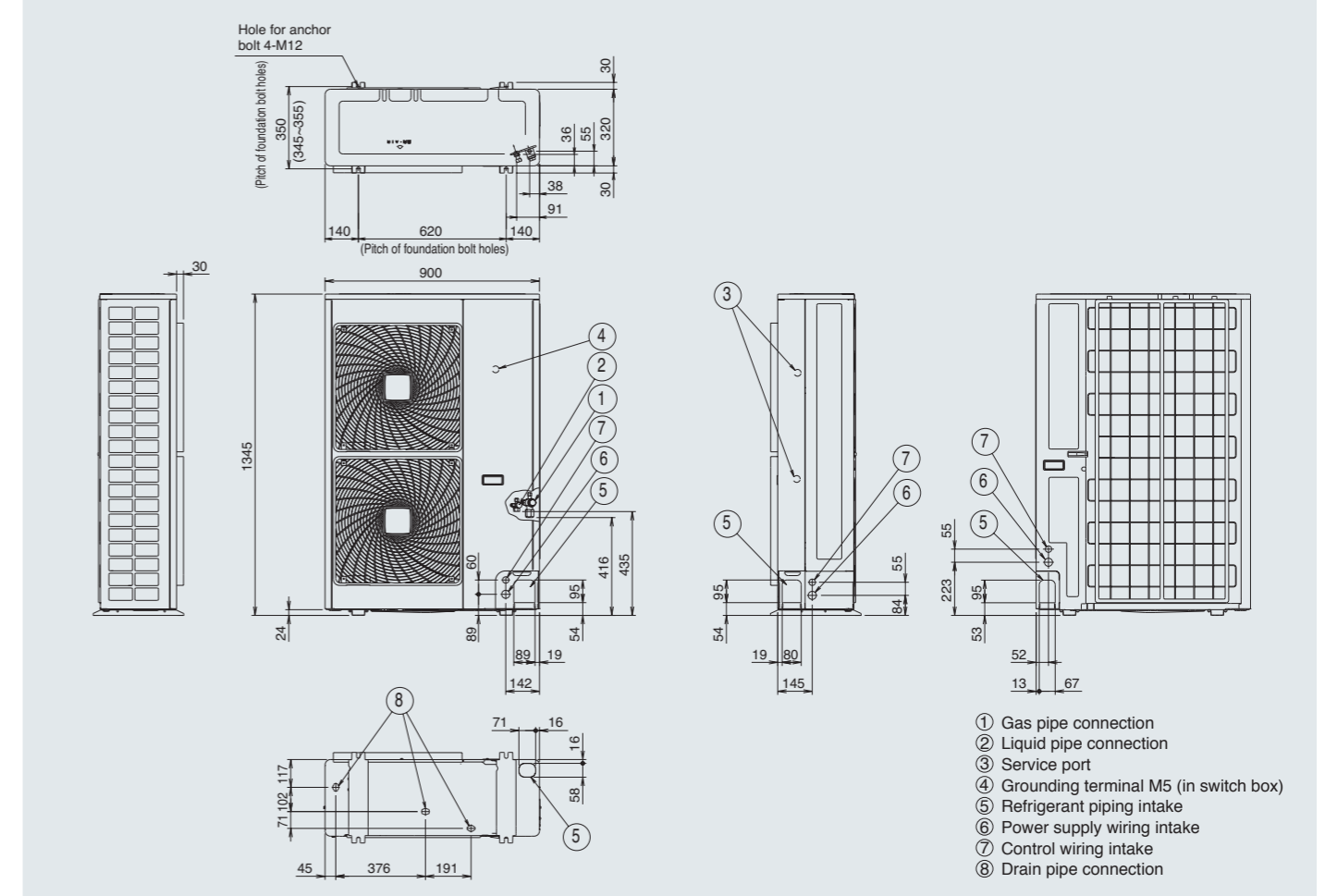

REMOTE CONTROLLER

《Wireless type》

Remote controller dimensions

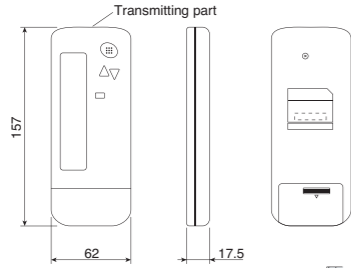

Remote controller holder installation procedure

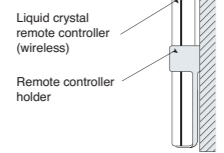

CEILING MOUNTED CASSETTE TYPE <Round Flow>

Receiver installation procedure

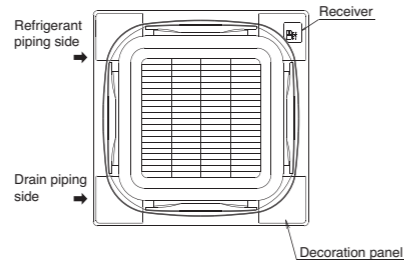

Receiver detail

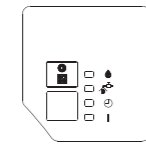

COMPACT MULTI FLOW CEILING MOUNTED CASSETTE TYPE

Receiver installation procedure

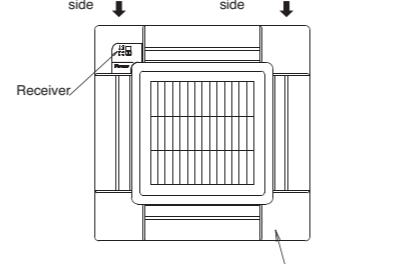

Receiver detail

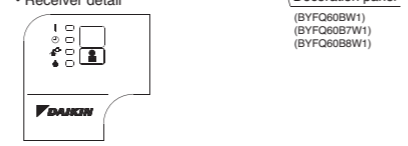

CEILING MOUNTED BUILT-IN TYPE DUCT CONNECTION MIDDLE STATIC PRESSURE TYPE

Receiver detail

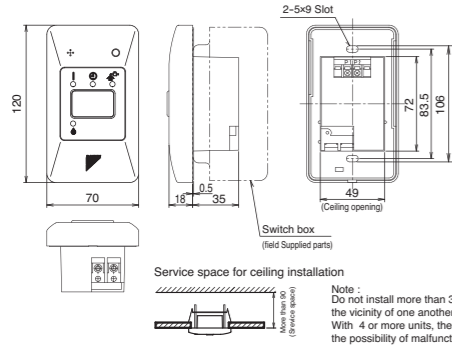

CEILING SUSPENDED TYPE

Receiver installation procedure

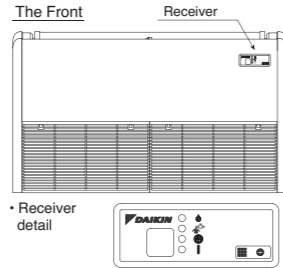

WALL MOUNTED TYPE

Receiver installation procedure

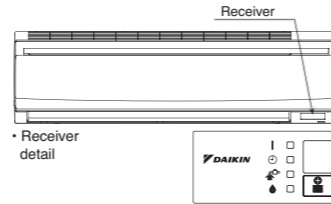

《Wired type》 Remote controller dimensions

BRC2E61

Installation method

- A Exposed body, exposed cord
- B Exposed body, embedded cord
- C Exposed body, embedded code

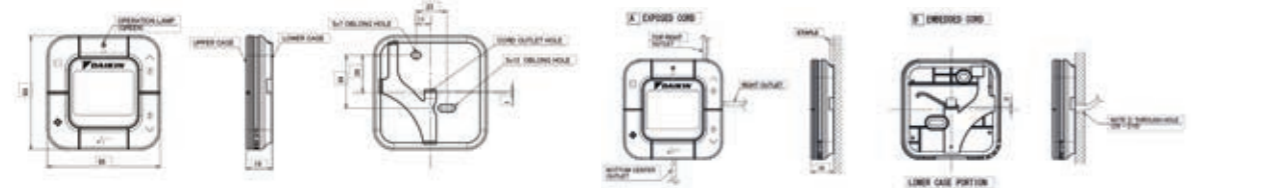

Type *	Shield wire (insulated thickness: 1 mm or more)
Size	0.75~1.25 mm <sup>2</sup>
Total length	500 m

Note) 1. Remote controller cord and staple are not attached. They are field supplied parts.

BRC1E63

Installation method

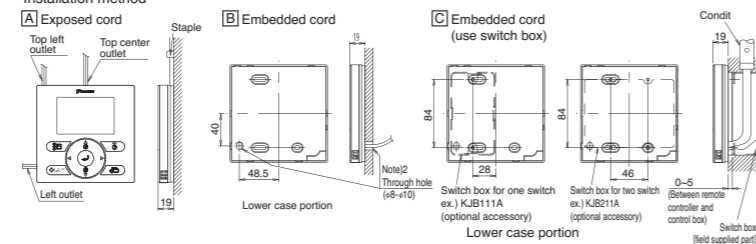

Note) 1. Remote controller cord and staple are not attached. They are field supplied parts.

Specifications of cord

Type	Vinyl cord with sheath or cable (insulated thickness: 1 mm or more)
Size	0.75~1.25 mm <sup>2</sup>
Total length	500 m

Note) 2. If the hole size is too large or the location is not proper, the hole may come out from the remote controller.

For RZR50-71MVM, RZR100-140MYM, RZQ series

★1. RZR50/60/71MVM ★2. RZR100-140MYM, RZQ series

1 When there is an obstruction on the inlet side

1) When the overhead space is open

1. For single unit installation

When there is an obstruction only on the inlet side

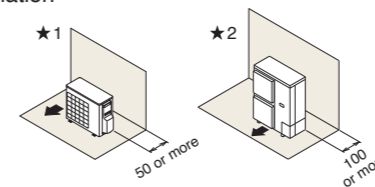

When there are obstructions on both sides

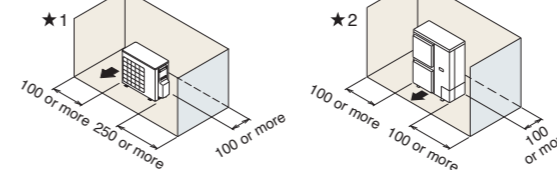

2. For multiple units installation (more than two units)

When there are obstructions on both sides

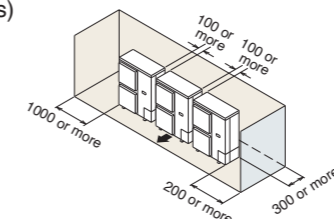

2) When there is an obstruction in the overhead space

1. For single unit installation

When there is an obstruction on the inlet side

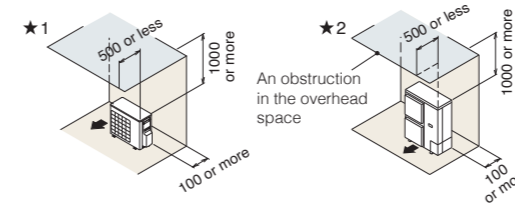

When there are obstructions on the inlet side and both lateral sides

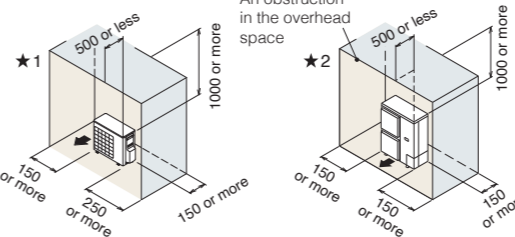

2. For series installation (more than two units)

When there are obstructions on the inlet side and both lateral sides

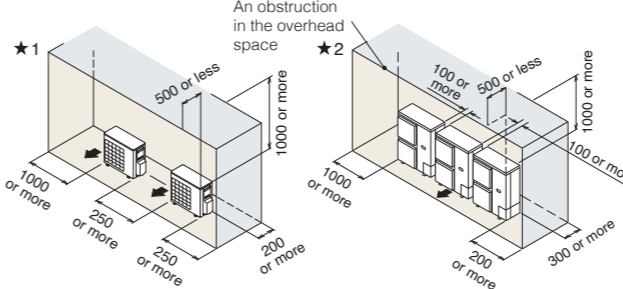

2) When there is an obstruction on the outlet side

1) When the overhead space is open

1. For single unit installation

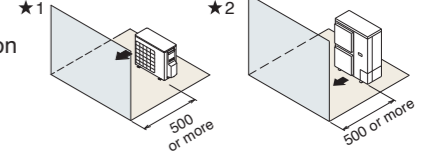

2. For multiple units installation (more than two units)

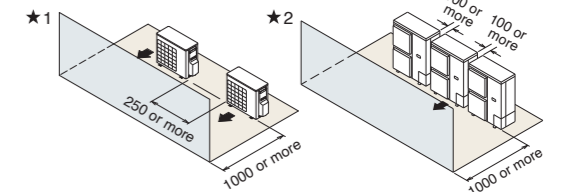

2) When there is an obstruction in the overhead space

1. For single unit installation

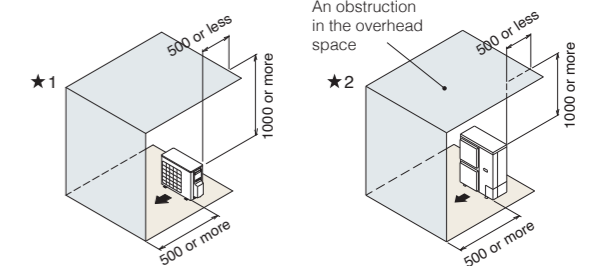

2. For multiple units installation (more than two units)

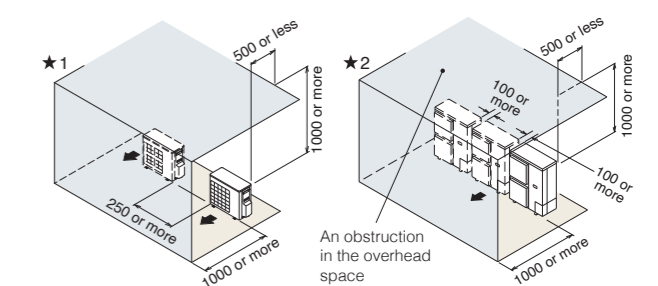

3) When there are obstructions on both the inlet and outlet sides

(When the obstruction on the outlet side is higher than the unit itself)

1) When the overhead space is open

(There is no limit to the height of the obstruction on the outlet side.)

1. For single unit installation

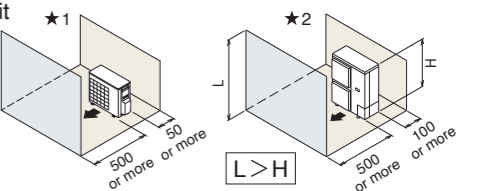

2. For series installation (more than two units)

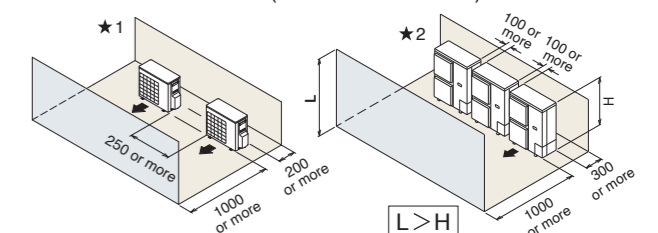

Note : As for other patterns of installation, please refer to Installation manual or Engineering Data Book.